

# MOUNTING AND OPERATING INSTRUCTIONS

## IP 9519-1 EN (100050753)

Media 5 · Option module with 4 to 20 mA current output

Firmware version 1.02

SAMSON

These instructions supplement the mounting and operating instructions ► EB 9519, which contains detailed information on the Media 5 Differential Pressure and Flow Meter.



Current output option module installed in the indicating unit

## 1 Nameplate

A self-adhesive nameplate is included in the retrofit kit for the option module. It must be affixed to the indicating unit after the option module is installed. A nameplate is already affixed when the option module is already installed upon delivery.

The nameplates shown were up to date at the time of publication of this document. The nameplate on the device may differ from the one shown.

### Nameplate of version without explosion protection:

<b>SAMSON 5005-0</b> Module	CE	5	4
$I_{OUT} = 4 \text{ to } 20 \text{ mA}$ , $U_{IN} = 12 \text{ to } 36 \text{ V DC}$			
⚠ WARNING - POTENTIAL ELECTROSTATIC CHARGING HAZARD - SEE INSTRUCTIONS			
Firmware <b>1</b>			
Material <b>2</b>	Serial no. <b>3</b>		
SAMSON AG, Germany			
Made in Germany			

### Nameplate of version with explosion protection:

<b>SAMSON 5005-3</b>	CE	0044	4
$I_{OUT} = 4 \text{ to } 20 \text{ mA}$ , $U_{IN} = 12 \text{ to } 28 \text{ VDC}$			
Ex ia IIC T4 Gb   Ex II 2 G Ex ia IIC T4 Gb			
IECEx KIWA 19.0013X   KIWA 19 ATEX 0023 X			
$U_i \leq 28 \text{ V DC}$ ; $I_i \leq 115 \text{ mA}$ ; $P \leq 1.0 \text{ W}$ ; $C \approx 10 \text{ nF}$ ; $L \approx 0 \text{ mH}$			
⚠ WARNING - POTENTIAL ELECTROSTATIC CHARGING HAZARD			
SEE INSTRUCTIONS -20 °C ≤ T <sub>a</sub> ≤ +70 °C			
Material <b>2</b>	Serial no. <b>3</b>	Firmware <b>1</b>	
SAMSON AG, Germany			
Made in Germany			

- 1 Firmware version
- 2 Material number
- 3 Serial number
- 4 Identification code (scannable)
- 5 Other mark of conformity

### 2 Design and principle of operation

The option module with a 4 to 20 mA current loop can be added to the Media 5 Differential Pressure and Flow Meter. It allows the measured value to be electronically processed for measuring and control tasks. The loop current is proportional to the pressure and is measured from the pointer position of the Media 5 device without any contact or interference.

The option module is installed in the Media 5 device. When ordered together with the Media 5 device, it is installed already in the delivered state. In all other cases, it can be retrofitted by the customer.

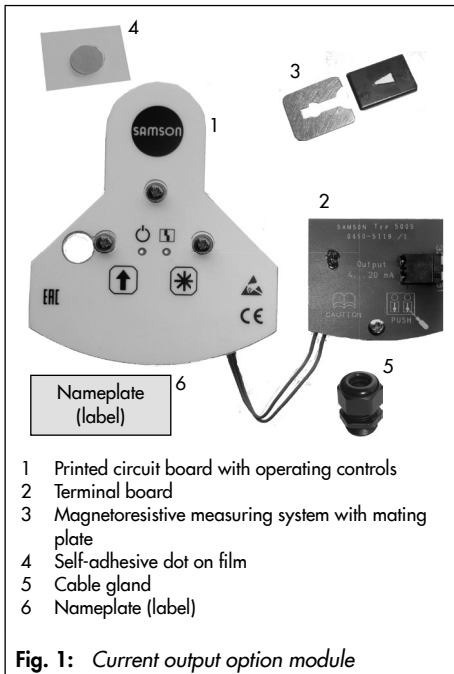

Fig. 1: Current output option module

#### Notes on explosion protection

The option module is available in two different versions:

The following applies to the version **with explosion protection** (100049064):

1. When working on explosion-protected versions of the option module, personnel must undergo special training or instructions or be authorized to work on explosion-protected devices in hazardous areas.
2. The current loop must be supplied only by a supply unit which has an equivalent or higher explosion protection approval. Its electrical connection data must be lower or identical to those in the explosion protection certificate of the Type 5005-3 device.
3. Permission to operate the option module in hazardous areas becomes void after the following events:
  - **One of the permissible electrical values listed in the explosion-protection certificate is exceeded, even when only briefly.** To continue operation of the option module in hazardous areas in such cases, SAMSON or persons with corresponding qualifications must provide evidence that all safety/protection features within the device or module are fully effective.
  - **The specifications described in 2. for the supply unit are not observed.** Operation of the option module must not be continued in such cases. The option module must be replaced.

The following applies to the version **without explosion protection** (100033844):

- Use of the option module in hazardous areas is not permissible.

## 2.1 Technical data

4 to 20 mA current output	Module 100049064 with explosion protection <sup>1)</sup>	Module 100033844 without explosion protection
Version	Magneto-resistive measuring system	
Supply voltage $U_B$	12 to 28 V DC	12 to 36 V DC
Output signal	4 to 20 mA, two-wire system according to DIN 66258	
Perm. load $R_B$ in $\Omega$	$R_B = (U_B - 12 \text{ V}) / 0.020 \text{ A}$   ( $R \leq 600 \Omega$ at 24 V and 20 mA)	
Power consumption	0.252 mW for 12 V DC and 21 mA	
Settings	Zero calibration   Span calibration   Characteristic selection   Test function	
Characteristic	Output and reading linear or square root extraction depending on installed flow characteristic Characteristic set at the factory	
Deviation from terminal-based linearity	$< \pm 0.2 \%$ , related to $270^\circ$ measuring span	
Sensitivity	$< \pm 0.05 \%$ , related to $270^\circ$ measuring span	
Effect of ambient temperature in the range from $-40$ to $+80 \text{ }^\circ\text{C}$	$< 0.1 \%$ / 10 K for zero and span	
Type of protection	ATEX: II 2 G Ex ia IIC T4 Gb IECEx: Ex ia IIC T4 Gb	–
Conformity		

<sup>1)</sup> The technical data for the explosion-protected devices may be restricted by the limits specified in the test certificates.

### 3 Installation

**⚠ DANGER**

**Risk of fatal injury due to the ignition of an explosive atmosphere.**

➔ For mounting and electrical installation in hazardous areas, observe the explosion protection approvals as well as the relevant electrotechnical regulations and the accident prevention regulations that apply in the country of use. EN 60079-14 applies in Europe.

➔ Installation, operation or maintenance of the differential pressure and flow meter is to be performed only by personnel with qualifications according to Clause 4.5 of IEC 60079-14 who has undergone special training or instructions or who is authorized to work on explosion-protected devices in hazardous areas.

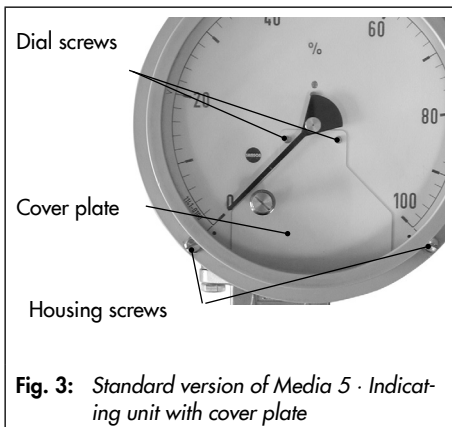

1. Undo the four housing screws. Remove the housing cover.
2. Unscrew the two dial plate screws and remove the cover plate. Retighten dial plate screws.
3. Place the magnetoresistive measuring system on the pointer:
  - Self-adhesive dot on film: pull off brown backing.
  - Stick the film with self-adhesive dot, adhesive side facing downward, centrally on the pointer axis.
  - Pull off film. Make sure that the self-adhesive dot remains stuck on.
  - Place the magnetoresistive measuring system, with the **arrow** pointing toward the **pointer**, onto the pointer axis. Press it down.

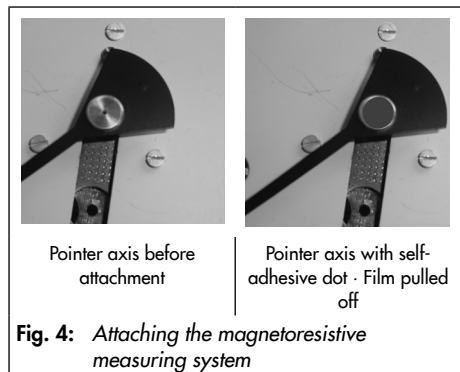

4. Turn the pointer from the zero position to the approx. 90° position.

- Slide the mating plate underneath the pointer and magneto-resistive measuring system to fasten the elements together. Make sure it fits properly. Pay attention to the counterweight at the end of the pointer.

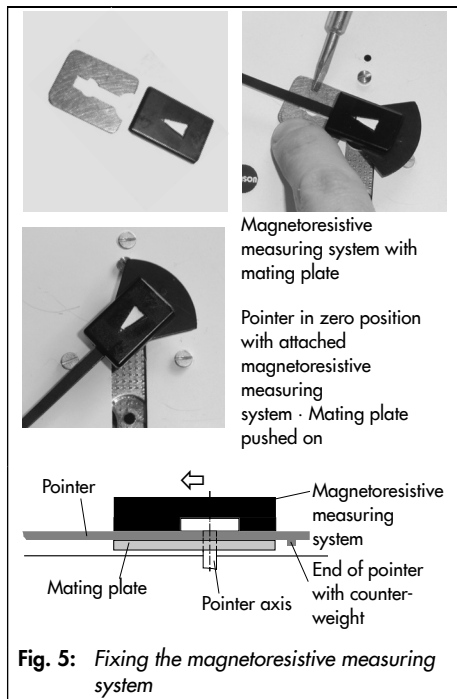

- If the terminal board has not yet been connected, connect the connecting cable and connector at the back of the printed circuit board.

Plug the micro connector into the socket on the printed circuit board.

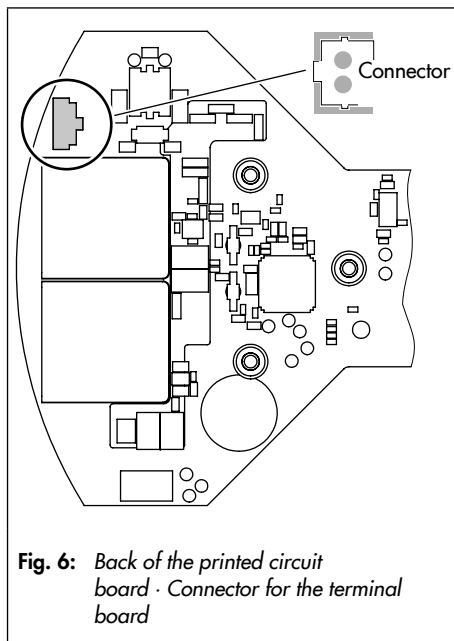

- Place on the current output option module with connected terminal board in place of the cover plate.

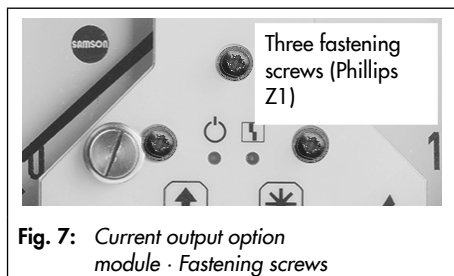

## Installation

8. Fasten the option module using the three fastening screws (Phillips Z1)
9. Insert the terminal board at the side underneath the dial plate.  
Use Phillips screwdriver to tighten the retaining screw.
10. Insert the connecting cable into the guiding of the indicating unit.

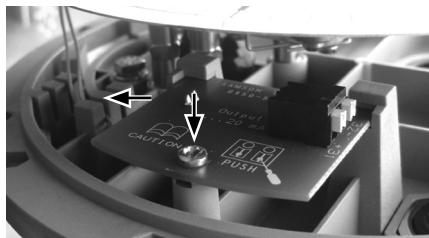

Fig. 8: Inserting the terminal board

11. Guide the measuring signal lines (min. 8 mm stripped length) through the cable gland and connect them to the spring-cage terminal (31, 32) on the terminal board (see Fig. 9). Observe the correct polarity.

### Measuring signal connection

The option module with current output is designed as a two-wire system.

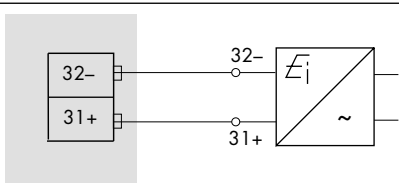

Fig. 9: Measuring signal connection in two-wire system

The option module consists of an actively controlled current loop with a 4 to 20 mA loop current. This current depends on the position of the pointer on the Media 5 device:

- Pointer position 0 to 270° corresponds with the 4 to 20 mA loop current.

The measuring signal and supply voltage of the option module are transmitted by the same pair of wires. It is connected to the terminal board over two spring-cage terminals.

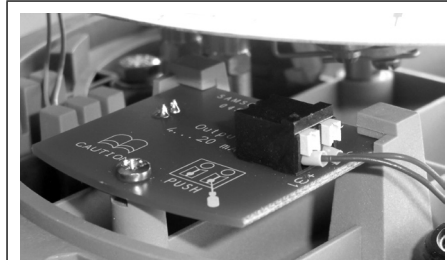

Fig. 10: Connecting the measuring signal lines on the terminal board

The Media 5 Differential Pressure and Flow Meter supplies a 4 to 20 mA current regardless of the supply voltage.

### NOTICE

**Risk of the supply voltage falling lower than the required level due to the use of a shunt.**

- To maintain the functioning of the option module when a shunt is used, apply the following formula to take the loop voltage into account:  $U_{\text{Loop-min}} = 12 \text{ V} + (R_{\text{shunt}} \times 21 \text{ mA})$

### 3.1 Settings

The option module has a **green** LED (1) and a **red** LED (2) as well as a **↑** key (3) and **\*** key (4) to perform settings.

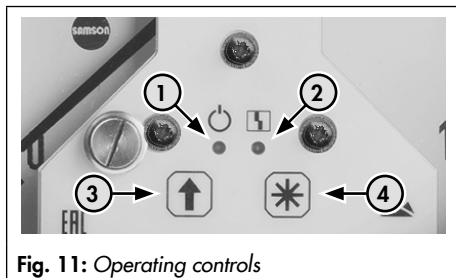

Fig. 11: Operating controls

<b>Green LED</b>	<b>Status indication</b> (standard operation)
<b>Red LED</b>	<b>Error indication</b> (LED permanently on) Press <b>*</b> key to confirm. The unit is restarted.
<b>* key</b>	<b>Execute/confirm</b> The <b>red</b> LED blinks briefly once to indicate that a function is being performed. After completion, the unit returns to standard operation.
<b>↑ key</b>	<b>Select function/data</b>

The **green** LED indicates standard operation of the option module. Four different levels can be selected.

Press the **↑** key to change between levels. The LED blinking pattern indicates which level has been selected.

Level	Blinking pattern
<b>Zero calibration</b>	■ ■ ■
<b>Span calibration</b>	■ ■
<b>Characteristic</b>	■■■ ■■■ ■■■
<b>4 mA/20 mA ammeter</b>	■■■■ ■■■■ ■■■■

#### Zero calibration

The electric zero is adapted to the mechanical zero. As a result, a 4 mA signal is also issued at  $\Delta p = 0$  bar corresponding to the pointer's zero point.

Zero can be calibrated in the scale range between approx.  $-5^\circ$  and  $135^\circ$  (see Fig. 12).

Activate **zero calibration** level

Key	LED	Function
1x <b>↑</b> key	<b>Green</b>	Blinking pattern ■ ■ ■
<b>*</b> key	<b>Red</b>	Zero calibration active The <b>red</b> LED blinks briefly once to indicate that calibration is in progress. Current pointer position $\hat{=}$ 4 mA.
	<b>Green</b>	Change to standard operation

The **red** LED is permanently lit (error indication) if the calibration range is exceeded.

#### Span calibration

The measuring span can be calibrated continuously without affecting zero or the measuring accuracy (see Fig. 12). The pointer position corresponds to the end point with 20 mA output signal.

As a result, the end points can easily be adapted to the measured medium, especially when attachable or multiple dial plates are used.

A measuring span calibration is possible in the pointer range  $>95^\circ$  (based on the pointer's zero point, see Fig. 12).

The **red** LED is permanently lit (error indication) if the calibration range is exceeded.

## Installation

### Activate *span calibration* level

Key	LED	Function
2x↑ key	Green	Blinking pattern ■ ■
* key	Red	Span calibration active The red LED blinks briefly once to indicate that calibration is in progress. Current pointer position $\cong$ 20 mA.
	Green	Change to standard operation

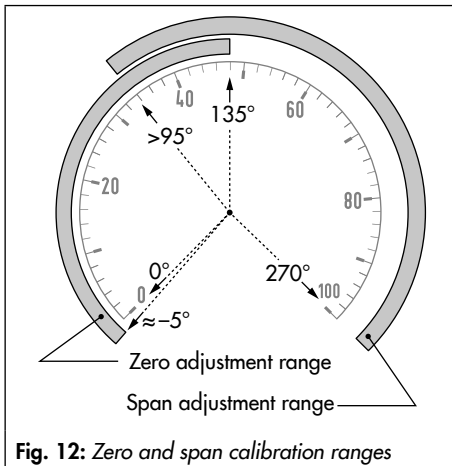

### Characteristic

Three characteristics are available.

- Linear ■ ■ ■
- Root-extracting ■ ■ ■
- User-defined ■ ■ ■ ■ (factory setting)

### Activate *characteristic* level

Key	LED	Function
3x↑ key	Green	Blinking pattern ■ ■ ■ ■ ■ ■
* key	Red	The blinking pattern indicates which characteristic is currently selected.
↑ key	Red	Every time the key is pressed, the blinking pattern changes: ■ ■ ■ ↑ ■ ■ ■ ↑ ■ ■ ■ ■ ■ ■ Blinking pattern $\cong$ Characteristic.
* key	Red	Confirm.
	Green	Change to standard operation

### 4 mA/20 mA ammeter

To calibrate the assessment unit, 4 and 20 mA test signals are issued.

### Activate *4 mA/20 mA ammeter* level

Key	LED	Function
4x↑ key	Green	Blinking pattern ■ ■ ■ ■ ■ ■ ■ ■
* key	Red	Blinking pattern ■ ■ ■ $\cong$ 4 mA output.
↑ key	Red	Blinking pattern ■ ■ ■ $\cong$ 20 mA output.
* key	Red	Exit function.
	Green	Change to standard operation



### Canceling operation

Operation can be canceled at all times without data being saved.

- Press **↑** key together with the **\*** key:  
The option module returns to standard operation.

### Error message

A permanently lit **red** LED indicates an error (e.g. zero or span calibration range exceeded, ammeter defective).

- Press **\*** key to confirm.  
The option module is restarted and goes into standard operation.

### Operation timeout

If no key is pressed within three minutes while a level is active, the unit automatically returns to standard operation.

The option module returns to standard operation.

## 4 Servicing explosion-protected devices

- Observe the following for servicing equipment in a section relevant to explosion protection:
  - It must not be put back into operation until a qualified inspector has assessed the equipment according to explosion protection requirements, has issued an inspection certificate or given the device a mark of conformity. Inspection by a qualified

inspector is not required if the manufacturer performed a routine test on the device before putting it back into operation. Document the passing of the routine test by attaching a mark of conformity to the device.

- Replace explosion-protected components only with original, routine-tested components by the manufacturer.
- Devices that have already been used outside hazardous areas and are intended for future use inside hazardous areas must comply with the safety requirements placed on serviced devices. They must be subjected to testing according to the specifications in EN 60079-19.
- EN 60079-19 applies to servicing explosion-protected devices.
- Use the protective cable designed by SAMSON when interconnecting non-intrinsically safe set point calibrators with intrinsically safe equipment for repair, calibration etc. to ensure that components relevant to explosion protection are not damaged.

## 5 Disposal



SAMSON is a producer registered in Europe.  
▶ [www.samsongroup.com](http://www.samsongroup.com) > About SAMSON > Environment, Social & Governance > Material Compliance > Waste electrical and electronic equipment (WEEE)  
WEEE reg. no.: DE 62194439

Information on substances listed as substances of very high concern (SVHC) on the candidate list of the REACH regulation can be found in the document "Additional Information on Your Inquiry/Order", which is added to the order documents, if applicable. This document includes the SCIP number assigned to the devices concerned. This number can be entered into the database on the European Chemicals Agency (ECHA) website (▶ <https://www.echa.europa.eu/scip-database>) to find out more information on the SVHC contained in the device.

### **i** Note

*SAMSON can provide you with a recycling passport according to PAS 1049 on request. Simply e-mail us at [aftersaleservice@samsongroup.com](mailto:aftersaleservice@samsongroup.com) giving details of your company address.*

### Tip

*On request, SAMSON can appoint a service provider to dismantle and recycle the product as part of a distributor take-back scheme.*

- ➔ Observe local, national and international refuse regulations.
- ➔ Do not dispose of components, lubricants and hazardous substances together with your other household waste.



SAMSON AKTIENGESELLSCHAFT  
Weismüllerstraße 3 · 60314 Frankfurt am Main, Germany  
Phone: +49 69 4009-0 · Fax: +49 69 4009-1507  
[samson@samsongroup.com](mailto:samson@samsongroup.com) · [www.samsongroup.com](http://www.samsongroup.com)