

MOUNTING AND OPERATING INSTRUCTIONS



EB 5827-2 EN

Translation of original instructions



Type 5827 Electric Actuator
Version with digital positioner

Firmware version 2.00

Edition February 2025



Note on these mounting and operating instructions

These mounting and operating instructions (EB) assist you in mounting and operating the device safely. The instructions are binding for handling SAMSON devices. The images shown in this document are for illustration purposes only. The actual product may vary.

- ⇒ For the safe and proper use of these instructions, read them carefully and keep them for later reference.
- ⇒ If you have any additional questions not related to the contents of this document, contact SAMSON's After-sales Service (aftersaleservice@samsongroup.com).



Documents relating to the device, such as the mounting and operating instructions, are available on our website:

▶ <https://www.samsongroup.com/en/downloads/documentation>

Definition of signal words

⚠ DANGER

Hazardous situations which, if not avoided, will result in death or serious injury

⚠ WARNING

Hazardous situations which, if not avoided, could result in death or serious injury

ⓘ NOTICE

Property damage message or malfunction

i Note

Additional information

💡 Tip

Recommended action

| | | |
|----------|--|-----------|
| 1 | Safety instructions and measures..... | 5 |
| 1.1 | Notes on possible severe personal injury..... | 6 |
| 1.2 | Notes on possible personal injury..... | 7 |
| 1.3 | Notes on possible property damage..... | 7 |
| 1.4 | Warnings on the device..... | 8 |
| 2 | Markings on the device..... | 9 |
| 2.1 | Nameplate..... | 9 |
| 2.2 | Device code..... | 10 |
| 3 | Design and principle of operation..... | 11 |
| 3.1 | Fail-safe action..... | 11 |
| 3.2 | Manual override..... | 11 |
| 3.3 | Communication..... | 12 |
| 3.4 | Configuration..... | 12 |
| 3.5 | Additional equipment..... | 13 |
| 3.6 | Technical data..... | 13 |
| 3.7 | Dimensions..... | 16 |
| 3.8 | Replacement of old actuators with new actuators (valve is retained)..... | 17 |
| 4 | Shipment and on-site transport..... | 18 |
| 4.1 | Accepting the delivered goods..... | 18 |
| 4.2 | Removing the packaging from the actuator..... | 18 |
| 4.3 | Transporting the actuator..... | 18 |
| 4.4 | Lifting the actuator..... | 18 |
| 4.5 | Storing the actuator..... | 18 |
| 5 | Installation..... | 19 |
| 5.1 | Installation conditions..... | 19 |
| 5.2 | Preparation for installation..... | 19 |
| 5.3 | Aligning the travel indication scale..... | 20 |
| 5.4 | Mounting the actuator..... | 20 |
| 5.4.1 | Actuator without fail-safe action..... | 21 |
| 5.4.2 | Actuator with fail-safe action..... | 21 |
| 5.5 | Installing the control valve into the pipeline..... | 22 |
| 5.6 | Electrical connection..... | 22 |
| 6 | Operation..... | 24 |
| 6.1 | Device overview and operating controls..... | 24 |
| 6.1.1 | LED indication..... | 24 |
| 6.1.2 | Function switch..... | 24 |
| 6.1.3 | Operating direction switch..... | 25 |
| 6.1.4 | Actuating shaft (opened front housing cover)..... | 25 |
| 7 | Start-up and configuration..... | 26 |
| 7.1 | Initializing the actuator..... | 26 |
| 7.2 | Configuring the actuator..... | 27 |
| 7.3 | Adjusting the limit contacts..... | 27 |
| 8 | Setup..... | 29 |
| 8.1 | Positioner..... | 29 |
| 8.2 | LED blinking pattern..... | 29 |
| 8.3 | Manual mode..... | 30 |
| 8.3.1 | Mechanical override..... | 30 |
| 8.4 | Operation using memory pen..... | 31 |
| 8.4.1 | Copying function..... | 33 |
| 8.4.2 | Data logging..... | 33 |

Contents

| | | |
|-----------|--|-----------|
| 8.4.3 | Command mode..... | 33 |
| 8.5 | Readings in TROVIS-VIEW..... | 35 |
| 8.5.1 | Operating values..... | 35 |
| 8.5.2 | Operating states..... | 35 |
| 8.5.3 | Functions..... | 36 |
| 8.5.4 | Status messages..... | 36 |
| 8.5.5 | Statistics..... | 37 |
| 9 | Malfunctions..... | 38 |
| 9.1 | Troubleshooting..... | 38 |
| 9.2 | Error indication by LEDs..... | 38 |
| 9.3 | Emergency action..... | 40 |
| 10 | Servicing..... | 41 |
| 11 | Decommissioning..... | 42 |
| 12 | Removal..... | 43 |
| 12.1 | Force-locking attachment..... | 43 |
| 12.2 | Form-fit attachment..... | 43 |
| 13 | Repair..... | 45 |
| 13.1 | Returning the actuator to SAMSON..... | 45 |
| 14 | Disposal..... | 46 |
| 15 | Certificates..... | 47 |
| 16 | Appendix A..... | 56 |
| 16.1 | Location of LEDs and switches..... | 56 |
| 16.1.1 | LEDs..... | 56 |
| 16.1.2 | Function switch..... | 56 |
| 16.1.3 | Operating direction switch..... | 57 |
| 16.2 | Input signal..... | 57 |
| 16.2.1 | Split-range operation..... | 57 |
| 16.3 | Position feedback signal..... | 58 |
| 16.4 | Functions..... | 58 |
| 16.4.1 | Detect input signal failure..... | 58 |
| 16.4.2 | End position guiding..... | 59 |
| 16.5 | Blockage..... | 59 |
| 16.5.1 | Blocking protection..... | 59 |
| 16.6 | Travel..... | 59 |
| 16.6.1 | Limited travel range..... | 59 |
| 16.6.2 | Travel adjustment..... | 60 |
| 16.6.3 | Idle time during end position guiding..... | 60 |
| 16.6.4 | Speed..... | 61 |
| 16.6.5 | Dead band (switching range)..... | 61 |
| 16.6.6 | Characteristic..... | 61 |
| 16.6.7 | Start-up..... | 62 |
| 16.6.8 | Functions ('Service')..... | 62 |
| 16.6.8.1 | Manual level..... | 62 |
| 16.6.8.2 | Functions..... | 63 |
| 17 | Appendix B..... | 64 |
| 17.1 | Accessories..... | 64 |
| 17.2 | After-sales service..... | 65 |
| 17.3 | Configuration list and customer-specific data..... | 66 |

1 Safety instructions and measures

Intended use

The Type 5827 Electric Actuator is designed to operate a mounted globe valve used in industrial applications as well as in heating, ventilation and air-conditioning systems.

The digital positioner ensures a predetermined assignment of the valve position to the input signal. The actuator is designed to operate under exactly defined conditions (e.g. thrust, travel). Therefore, operators must ensure that the actuator is only used in operating conditions that meet the specifications used for sizing the actuator at the ordering stage. In case operators intend to use the actuator in applications or conditions other than those specified, contact SAMSON.

SAMSON does not assume any liability for damage resulting from the failure to use the device for its intended purpose or for damage caused by external forces or any other external factors.

⇒ Refer to the technical data for limits and fields of application as well as possible uses (see Chapter 3).

Reasonably foreseeable misuse

The actuator is not suitable for the following applications:

- Use outside the limits defined during sizing and by the technical data
- Outdoor use

Furthermore, the following activities do not comply with the intended use:

- Use of non-original spare parts
- Performing service and repair work not described

Qualifications of operating personnel

The product (Type 5827) must be mounted, started up, serviced and repaired by fully trained and qualified personnel only; the accepted industry codes and practices must be observed. According to the mounting and operating instructions, trained personnel refers to individuals who are able to judge the work they are assigned to and recognize possible hazards due to their specialized training, their knowledge and experience as well as their knowledge of the applicable standards.

Personal protective equipment

No personal protective equipment is required for the direct handling of the electric actuator. Work on the control valve may be necessary when mounting or removing the device.

- ⇒ Observe the requirements for personal protective equipment specified in the valve documentation.
- ⇒ Check with the plant operator for details on further protective equipment.

Revisions and other modifications

Revisions, conversions or other modifications of the product (Type 5827) are not authorized by SAMSON. They are performed at the user's own risk and may lead to safety hazards, for example. Furthermore, the product may no longer meet the requirements for its intended use. Use of the device is no longer permitted in this case.

Safety features

The actuator automatically switches off when one of the end positions is reached.

Upon supply voltage failure, a valve, which has a Type 5827 Electric Actuator with fail-safe action mounted on it, moves to a certain fail-safe position. The direction of the fail-safe action is specified on the nameplate of SAMSON actuators.

Warning against residual hazards

The product (Type 5827) has a direct influence on the control valve. To avoid personal injury or property damage, plant operators and operating personnel must prevent hazards that could be caused in the control valve by the process medium, the operating pressure, the signal pressure or by moving parts by taking appropriate precautions.

Plant operators and operating personnel must observe all hazard statements, warnings and caution notes in these mounting and operating instructions, especially for installation, start-up and service work.

Responsibilities of the operator

Operators are responsible for proper use and compliance with the safety regulations. Operators are obliged to provide these mounting and operating instructions to the operating personnel and to instruct them in proper operation. Furthermore, operators must ensure that operating personnel or third parties are not exposed to any danger.

Safety instructions and measures

Responsibilities of operating personnel

Operating personnel must read and understand these mounting and operating instructions as well as the specified hazard statements, warnings and caution notes. Furthermore, operating personnel must be familiar with the applicable health, safety and accident prevention regulations and comply with them.

Referenced standards, directives and regulations

The product (Type 5827) with a CE marking fulfills the requirements of the following Directives:

- RoHS Directive 2011/65/EU
- EMC Directive 2014/30/EU
- Low-voltage Directive 2014/35/EU

The product (Type 5827) with an EAC marking fulfills the requirements of the following Directives:

- TR CU 004/2011
- TR CU 020/2011

The declarations of conformity and certificates are included in Chapter 15.

The product (Type 5827) with a CE marking is designed for use in low voltage installations.

- ⇒ For wiring, maintenance and repair, observe the relevant safety regulations.

Referenced documentation

The following documents apply in addition to these mounting and operating instructions:

Mounting and operating instructions of the valve on which the electric actuator is mounted, e.g. for SAMSON valves:

- ▶ EB 5861 for Type 3260 Three-way Valve
- ▶ EB 5863 for Type 3226 Three-way Valve
- ▶ EB 5866 for Type 3222 Globe Valve
- ▶ EB 5868-1 for Type 3213 and Type 3214 Globe Valves balanced by a diaphragm
- ▶ EB 8111/8112 for Type 3321 Globe Valve
- ▶ EB 8113/8114 for Type 3323 Three-way Valve
- ▶ EB 8131/8132 for Type 3531 Globe Valve for Heat Transfer Oil

- ▶ EB 8135/8136 for Type 3535 Three-way Valve for Heat Transfer Oil

1.1 Notes on possible severe personal injury



Risk of fatal injury due to electric shock.

- ⇒ Before connecting the wiring, performing any work on the device or opening the device, disconnect the supply voltage and protect it against unintentional reconnection.
- ⇒ Only use protective equipment that can be protected against unintentional reconnection of the power supply.
- ⇒ Do not remove any covers to perform adjustment work on live parts.

The electric actuator is protected against spray water (IP54).

- ⇒ Avoid jets of water.
- ⇒ Use suitable and approved cable grips.

1.2 Notes on possible personal injury

WARNING

Crush hazard arising from moving parts.

The following applies to actuators with form-fit attachment:

The electric actuator contains moving parts (actuator and plug stems), which can injure hands or fingers if inserted into the actuator.

- ⇒ Do not insert hands or finger into the yoke while the valve is in operation.
- ⇒ Before performing any work on the control valve or opening the electric device, disconnect the supply voltage and protect it against unintentional reconnection.
- ⇒ Do not impede the movement of the actuator or plug stem by inserting objects into their path.

Risk of personal injury due to incorrect operation, use or installation as a result of information on the actuator being illegible.

Over time, markings, labels and nameplates on the actuator may become covered with dirt or become illegible in some other way. As a result, hazards may go unnoticed and the necessary instructions not followed. There is a risk of personal injury.

- ⇒ Keep all relevant markings and inscriptions on the device in a constantly legible state.
- ⇒ Immediately renew damaged, missing or incorrect nameplates or labels.

Risk of injury due to a power surge.

The serial interface of the electric actuator is not fitted with a surge protector.

- ⇒ Ensure that surge protection is provided upon connecting cables.

1.3 Notes on possible property damage

NOTICE

Risk of damage to the electric actuator due to the supply voltage exceeding the permissible tolerances.

The Type 5827 Electric Actuator is designed for use according to regulations for low-voltage installations.

- ⇒ Observe the permissible tolerances of the supply voltage.

Risk of damage to the electric actuator due to over-torquing.

Observe the specified torques when tightening the mounting parts of Type 5827 Electric Actuators. Over-torquing leads to parts wearing out more quickly.

- ⇒ Observe the specified tightening torques.

Risk of damage to the electric actuator by moving the actuator stem too far.

The actuator stem of the electric actuator can be adjusted manually.

- ⇒ Move the actuator stem only as far as the bottom or top end position.

Risk of actuator damage due to foreign particles entering it.

- ⇒ Seal unused cable entries with suitable blanking plugs.
- ⇒ Do not guide cables through blanking plugs into the actuator housing.

Risk of damage to the electric actuator due to overvoltage.

The serial interface of the electric actuator is not fitted with a surge protector.

- ⇒ Ensure that surge protection is provided upon connecting cables.

Risk of actuator damage due to direct contact with steam.

- ⇒ Make sure that a mounted actuator cannot come into contact with a jet of steam while the control valve is in operation.

1.4 Warnings on the device

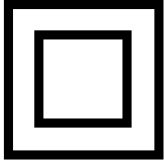
| Warning symbols | Meaning | Location on the device |
|---|---|------------------------|
|  | General warning ⇒ Refer to the mounting and operating instructions. | Inside the actuator |
|  | Class of protection II Only applies when the housing cover is attached and locked ⇒ Refer to the mounting and operating instructions. | Actuator housing |

2 Markings on the device

2.1 Nameplate

The nameplate shown was up to date at the time of publication of this document. The nameplate on the device may differ from the one shown.

- 16 Other mark of conformity
- 17 DIN test with register number (only version with "actuator stem extends" fail-safe action)
- 18 Other mark of conformity

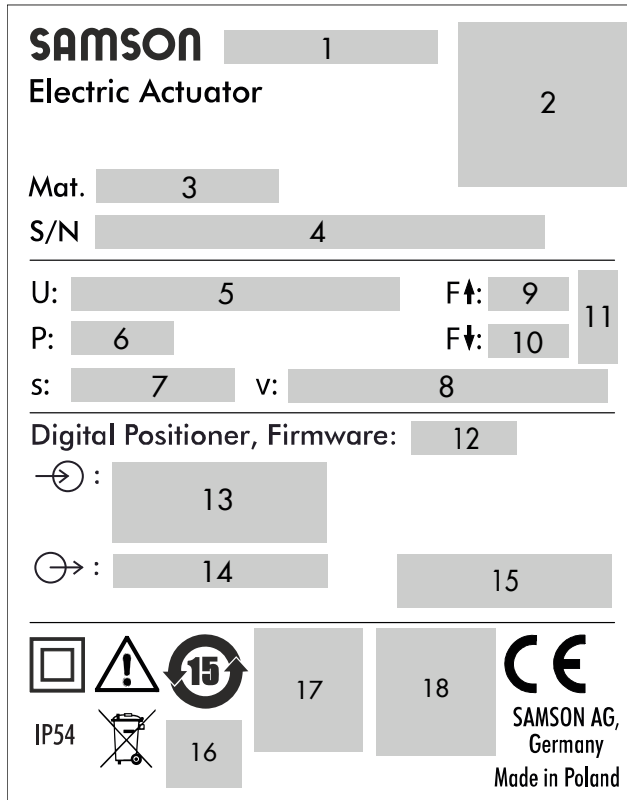

- 1 Type designation
- 2 Identification code (scannable)
- 3 Material number
- 4 Serial number, date of manufacture
- 5 Supply voltage; power line frequency
- 6 Power consumption
- 7 Rated travel
- 8 Stroking speed
- 9 Thrust (actuator stem retracts)
- 10 Thrust (actuator stem extends)
- 11 Direction of action (fail-safe action)



- 12 Firmware version

- 13 Input signal

- 14 Output signal

- 15 Limit contact

2.2 Device code

| | | | |
|-------------------------------------|----------|----------|----------|
| Type 5827- Electric Actuator | x | x | x |
| | | | |
| Fail-safe action | | | |
| Without | N | | |
| Actuator stem extends | A | | |
| Actuator stem retracts | E | | |
| Rated travel/adaptation | | | |
| 6 mm/force-locking | | 1 | |
| 12 mm/force-locking | | 2 | |
| 15 mm/form-fit | | 3 | |
| Control/supply voltage | | | |
| Positioner/24 V AC and DC | | | 4 |
| Positioner/85 to 264 V AC | | | 5 |

3 Design and principle of operation

The Type 5827 Electric Actuator is linear actuator, which is used in combination with SAMSON valves in industrial plants as well as in heating, ventilation and air-conditioning systems.

⇒ See Fig. 1.

A stepper motor allows for supply by frequency-independent voltages.

The force of the motor is transmitted to the actuator stem (3) via gearing and crank disk. When the actuator stem extends, the actuator piston (3) pushes against the valve's plug stem. When the actuator stem retracts (force-locking attachment), the plug stem follows the movement of the actuator stem as a result of the return spring in the valve.

When the actuator stem retracts (form-fit attachment), the plug stem is connected to the actuator stem and follows its movement.

The positioner ensures a predetermined assignment of the valve position to the control signal. For position feedback, a 0 to 10 V signal can be picked off at the output. The characteristic can be reversed. The electric actuator can be used for split-range operation.

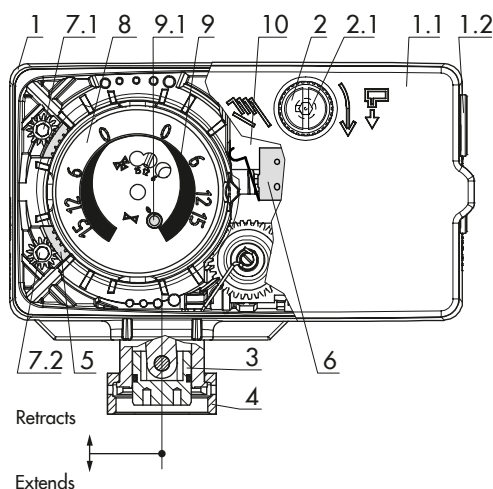

Fig. 1: Design of Type 5827 (force-locking attachment)

- 1 Housing
- 1.1 Front housing cover
- 1.2 Cable entry
- 2 Handwheel (Type 5827-Nxx only)
- 2.1 Actuating shaft
- 3 Actuator stem with actuator piston
- 4 Coupling nut
- 5 Cam disk
- 6 Mechanical limit contacts
- 7.1 Adjuster for limit contact (bottom contact cam)

- 7.2 Adjuster for limit contact (top contact cam)
- 8 Spring assembly (Types 5827-Axx and 5827-Exx only)
- 9 Travel indication scale
- 9.1 Driving pin
- 10 Torque switch

3.1 Fail-safe action

The Type 5827 Actuator is available with fail-safe action. The actuators with fail-safe action have a spring assembly and an electromagnet. The actuator is moved by the force of the spring to the fail-safe position when the electromagnet is de-energized. The direction of action depends on the actuator version and cannot be reversed.

- **“Actuator stem extends” fail-safe action:**
The actuator stem extends upon supply voltage failure.
- **“Actuator stem retracts” fail-safe action:**
The actuator stem retracts upon supply voltage failure.

NOTICE

Increased wear and shortened service life of the actuator.

⇒ Do not use the fail-safe action to control the valve position.

Electric actuators with fail-safe action do not have a handwheel. After disconnecting the supply voltage and opening the front housing cover, manual operation is possible with an Allen key. The actuator returns to its original position as soon as the Allen key is released.

Testing according to DIN EN 14597

Type 5827 Electric Actuators with “Actuator stem extends” fail-safe action which have a test mark on their nameplate are tested by the German technical surveillance association TÜV according to DIN EN 14597 in combination with different SAMSON valves (the register number is available on request).

3.2 Manual override

⇒ See Chapter 8.3.1.

The actuator without fail-safe action has a handwheel (2) used to manually position the valve. Travel and direction of action can be read off the travel indication scale (9).

Design and principle of operation

The electric actuator with fail-safe action largely corresponds to the version without fail-safe action described above. However, it contains a spring assembly (8) and an electromagnet, which move the connected valve to its fail-safe position when de-energized. It does not have a handwheel (2). After disconnecting the supply voltage and removing the front housing cover (1.1), manual operation is possible with an Allen key. The actuator returns to its original position as soon as the Allen key is released.

3.3 Communication

Serial interface

The actuator is fitted with an RS-232 serial interface as standard. This allows communication with TROVIS-VIEW using SSP protocol.

⇒ See Fig. 2.

⚠ WARNING

Risk of injury through a power surge.

The serial interface of the electric actuator is not fitted with a surge protector.

⇒ *Ensure that surge protection is provided upon connecting cables.*

ⓘ NOTICE

Risk of actuator damage due to overvoltage.

⇒ *Ensure that surge protection is provided upon connecting cables.*

ⓘ Note

The serial interface is exclusively intended for servicing purposes. It must only be used temporarily and not permanently.

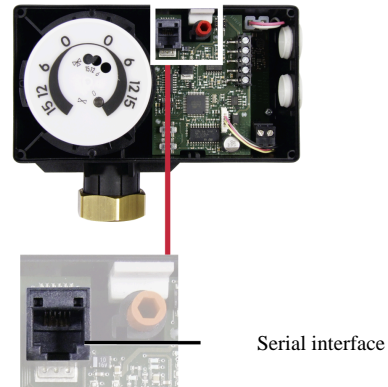

Fig. 2: Serial interface

3.4 Configuration

The actuator is configured with the TROVIS-VIEW software. In this case, the serial interface on the actuator is used to connect the actuator to the computer.

The TROVIS-VIEW software enables the user to easily configure the positioner as well as view process parameters online.

ⓘ Note

TROVIS-VIEW can be downloaded free of charge from the SAMSON website at ► www.samsongroup.com > DOWNLOADS > Software & Drivers > TROVIS-VIEW. Further information on TROVIS-VIEW (e.g. system requirements) is available on our website and in the Data Sheet ► T 6661 as well as in the Operating Instructions ► EB 6661.

⇒ See Chapter 7.

3.5 Additional equipment

Limit contacts

Optionally, the actuator can be equipped with two adjustable mechanical limit contacts. They are actuated by continuously adjustable cam disks.

They are only available in the version for 24 V AC/DC supply voltage.

The adjustment of the limit contacts is described in Chapter 5.

It is not possible to retrofit limit contacts.

3.6 Technical data

Table 1: Technical data · Type 5827-Nxx, version without fail-safe action

| Type 5827-N | | 14 | 15 | 24 | 25 | 34 | 35 |
|--|--|---|-----------------|-----------------|------|-----------------|------|
| Rated travel in mm | | 6 ¹⁾ | 6 ¹⁾ | 12 | 12 | 15 | 15 |
| Thrust in N | Extends | 700 | 700 | 700 | 700 | 700 | 700 |
| | Retracts | - | - | - | - | 700 | 700 |
| Manual override | | ✓ | ✓ | ✓ | ✓ | ✓ | ✓ |
| Stroking speed in mm/s (adjustable) | | | | | | | |
| | Slow | 0.13 | 0.13 | 0.13 | 0.13 | 0.13 | 0.13 |
| | Normal | 0.2 | 0.2 | 0.2 | 0.2 | 0.2 | 0.2 |
| | Fast | 0.36 | 0.36 | 0.36 | 0.36 | 0.36 | 0.36 |
| Transit time in s for rated travel | | | | | | | |
| | Slow | 45 | 45 | 89 | 89 | 111 | 111 |
| | Normal | 31 | 31 | 61 | 61 | 76 | 76 |
| | Fast | 17 | 17 | 33 | 33 | 41 | 41 |
| Attachment | Force-locking | ✓ | ✓ | ✓ | ✓ | - | - |
| | Form-fit | - | - | - | - | ✓ | ✓ |
| Supply voltage | | | | | | | |
| | 24 V (±10 %), 50 and 60 Hz 24 V DC (-10, +20 %) ³⁾ | ✓ | - | ✓ | - | ✓ | - |
| | 100 to 240 V (tolerance 85 to 264 V), 50 to 60 Hz (tolerance 47 to 63 Hz) | - | ✓ | - | ✓ | - | ✓ |
| Input signal | | 0 to 10 V, R _i = 20 kΩ · 0 to 20 mA, R _i = 50 Ω | | | | | |
| Output signal | | 0 to 10 V, R _B = 1 kΩ | | | | | |
| Power consumption in VA | | 5 ⁵⁾ | 8 | 5 ⁵⁾ | 8 | 5 ⁵⁾ | 8 |
| Weight in kg | | 0.75 | 0.75 | 0.75 | 0.75 | 0.75 | 0.75 |
| Additional equipment (cannot be retrofitted) | | | | | | | |
| | Two limit contacts, max. 240 V, max. 1 A, without contact protection ⁷⁾ | ✓ | - | ✓ | - | ✓ | - |

¹⁾ Actuators with 6 mm travel can also be used for valves with 7.5 mm travel.

³⁾ When the fast stroking speed setting is selected, the supply voltage must not fall below the specified value.

⁵⁾ Power consumption of 24 V DC version specified in W

⁷⁾ Contact protection with suitable spark suppression must be fitted for the switching contact. Observe the manufacturer's specifications concerning the connected load to select the appropriate spark suppression. A fuse, which is suitable for the application's circuit, must be used for the short-circuit and overload protection.

Design and principle of operation

Table 2: Technical data · Type 5827-Axx, version with “actuator stem extends” fail-safe action

| Type 5827-A | | 14 | 15 | 24 | 25 | 34 | 35 |
|--|--|---|-----------------|-----------------|------|-----------------|------|
| Rated travel in mm | | 6 ¹⁾ | 6 ¹⁾ | 12 | 12 | 15 | 15 |
| Thrust in N | Extends | 700 | 700 | 700 | 700 | 700 | 700 |
| | Retracts | - | - | - | - | 700 | 700 |
| Thrust in N in the event of fail-safe action | | 500 | 500 | 500 | 500 | 280 | 280 |
| Manual override | | ✓ ²⁾ | | | | | |
| Stroking speed in mm/s (adjustable) | | | | | | | |
| | Slow | 0.13 | 0.13 | 0.13 | 0.13 | 0.13 | 0.13 |
| | Normal | 0.2 | 0.2 | 0.2 | 0.2 | 0.2 | 0.2 |
| | Fast | 0.36 | 0.36 | 0.36 | 0.36 | 0.36 | 0.36 |
| Transit time in s for rated travel | | | | | | | |
| | Slow | 45 | 45 | 89 | 89 | 111 | 111 |
| | Normal | 31 | 31 | 61 | 61 | 76 | 76 |
| | Fast | 17 | 17 | 33 | 33 | 41 | 41 |
| Transit time in s in the event of fail-safe action | | 4 | 4 | 6 | 6 | 7 | 7 |
| Attachment | Force-locking | ✓ | ✓ | ✓ | ✓ | - | - |
| | Form-fit | - | - | - | - | ✓ | ✓ |
| Supply voltage | | | | | | | |
| | 24 V (±10 %), 50 and 60 Hz | ✓ ³⁾ | - | ✓ ³⁾ | - | ✓ | - |
| | 24 V DC (-10, +20 %) | ✓ ⁵⁾ | - | ✓ ⁵⁾ | - | ✓ ⁵⁾ | - |
| | 100 to 240 V (tolerance 85 to 264 V), 50 to 60 Hz (tolerance 47 to 63 Hz) | - | ✓ | - | ✓ | - | ✓ |
| Input signal | | 0 to 10 V, R _i = 20 kΩ · 0 to 20 mA, R _i = 50 Ω | | | | | |
| Output signal | | 0 to 10 V, R _B = 1 kΩ | | | | | |
| Power consumption in VA | | 8 ⁷⁾ | 10 | 8 ⁷⁾ | 10 | 8 ⁷⁾ | 10 |
| Weight in kg | | 1 | 1 | 1 | 1 | 1 | 1 |
| Additional equipment (cannot be retrofitted) | | | | | | | |
| | Two limit contacts, max. 240 V, max. 1 A, without contact protection ⁹⁾ | ✓ | - | ✓ | - | ✓ | - |
| | Testing according to DIN EN 14597 |  | | | | - | - |

¹⁾ Actuators with 6 mm travel can also be used for valves with 7.5 mm travel.

²⁾ With 4 mm Allen key

³⁾ Voltage tolerance for actuators tested according to DIN EN 14597: -15/+10 %

⁵⁾ When the fast stroking speed setting is selected, the supply voltage must not fall below the specified value.

⁷⁾ Power consumption of 24 V DC version specified in W

⁹⁾ Contact protection with suitable spark suppression must be fitted for the switching contact. Observe the manufacturer's specifications concerning the connected load to select the appropriate spark suppression. A fuse, which is suitable for the application's circuit, must be used for the short-circuit and overload protection.

Table 3: Technical data · Type 5827-Exx, version with “actuator stem retracts” fail-safe action

| Type 5827-E | | 14 | 15 | 24 | 25 | 34 | 35 |
|--|--|---|-----------------|-----------------|------|-----------------|------|
| Rated travel in mm | | 6 ¹⁾ | 6 ¹⁾ | 12 | 12 | 15 | 15 |
| Thrust in N | Extends | 500 | 500 | 500 | 500 | 280 | 280 |
| | Retracts | - | - | - | - | 280 | 280 |
| Thrust in N in the event of fail-safe action | | 280 | - | - | - | 280 | 280 |
| Manual override | | ✓ ²⁾ | | | | | |
| Stroking speed in mm/s (adjustable) | | | | | | | |
| | Slow | 0.13 | 0.13 | 0.13 | 0.13 | 0.13 | 0.13 |
| | Normal | 0.2 | 0.2 | 0.2 | 0.2 | 0.2 | 0.2 |
| | Fast | 0.36 | 0.36 | 0.36 | 0.36 | 0.36 | 0.36 |
| Transit time in s for rated travel | | | | | | | |
| | Slow | 45 | 45 | 89 | 89 | 111 | 111 |
| | Normal | 31 | 31 | 61 | 61 | 76 | 76 |
| | Fast | 17 | 17 | 33 | 33 | 41 | 41 |
| Transit time in s for fail-safe action | | 4 | 4 | 6 | 6 | 7 | 7 |
| Attachment | Force-locking | ✓ | ✓ | ✓ | ✓ | - | - |
| | Form-fit | - | - | - | - | ✓ | ✓ |
| Supply voltage | | | | | | | |
| | 24 V (±10 %), 50 and 60 Hz 24 V DC (-10, +20 %) ⁴⁾ | ✓ | - | ✓ | - | ✓ | - |
| | 100 to 240 V (tolerance 85 to 264 V), 50 to 60 Hz (tolerance 47 to 63 Hz) | - | ✓ | - | ✓ | - | ✓ |
| Input signal | | 0 to 10 V, R _i = 20 kΩ · 0 to 20 mA, R _i = 50 Ω | | | | | |
| Output signal | | 0 to 10 V, R _B = 1 kΩ | | | | | |
| Power consumption in VA | | 8 ⁵⁾ | 10 | 8 ⁵⁾ | 10 | 8 ⁵⁾ | 10 |
| Weight in kg | | 1 | 1 | 1 | 1 | 1 | 1 |
| Additional equipment (cannot be retrofitted) | | | | | | | |
| | Two limit contacts, max. 240 V, max. 1 A, without contact protection ⁶⁾ | ✓ | - | ✓ | - | ✓ | - |

¹⁾ Actuators with 6 mm travel can also be used for valves with 7.5 mm travel.

²⁾ With 4 mm Allen key

⁴⁾ When the fast stroking speed setting is selected, the supply voltage must not fall below the specified value.

⁵⁾ Power consumption of 24 V DC version specified in W

⁶⁾ Contact protection with suitable spark suppression must be fitted for the switching contact. Observe the manufacturer's specifications concerning the connected load to select the appropriate spark suppression. A fuse, which is suitable for the application's circuit, must be used for the short-circuit and overload protection.

Design and principle of operation

Table 4: Technical data · All versions

| Type 5827-N/-A/-E | |
|--|--|
| Safety | |
| Degree of protection ¹⁾ | IP54 according to EN 60529 |
| Class of protection ¹⁾ | II according to EN 61140 |
| Degree of contamination | 2 according to EN 60664-1 |
| Noise immunity | According to EN 61000-6-2 and EN 61326-1 |
| Noise emission | According to EN 61000-6-3 and EN 61326-1 |
| Electrical safety | According to EN 60730-1 and EN 60730-2-14 |
| Rated surge voltage | 2.5 kV according to EN 60730-1 |
| Vibration | According to EN 60068-2-64 and EN 60068-2-27 |
| Conformity | CE · EAC |
| Materials | |
| Housing, housing cover | Plastic (PPO with glass fiber reinforcement) |
| Coupling nut M32x1.5 | Brass |
| Ambient conditions | |
| Permissible temperature ranges ²⁾ | |
| Ambient | 0 to 50 °C |
| Storage | -20 to +70 °C |
| Humidity | 5 to 95 % moisture, no dew formation |
| Max. altitude above sea level | 2000 m |

¹⁾ Only with closed and locked front housing cover

²⁾ The permissible medium temperature depends on the valve on which the actuator is mounted. The limits in the valve documentation apply.

3.7 Dimensions

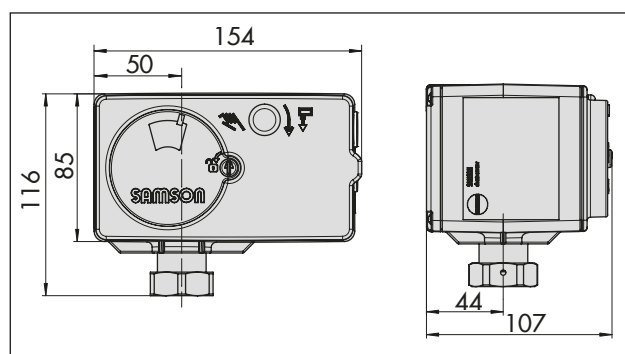

Fig. 3: Dimensions in mm · Force-locking attachment

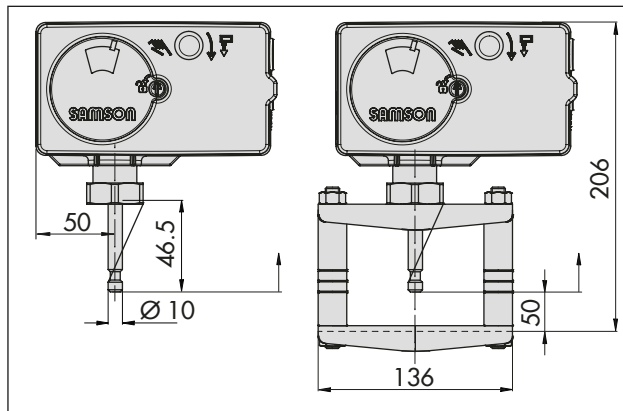

Fig. 4: Dimensions in mm · Form-fit attachment

3.8 Replacement of old actuators with new actuators (valve is retained)

| Old actuator | | New actuator | |
|--------------|-----------------------|--------------|----------|
| Type | 5824-10 | Type | 5827-N1x |
| | 5824-20 | | 5827-N2x |
| | 5824-30 | | 5827-N3x |
| | | | |
| | 5825-10 | | 5827-A1x |
| | 5825-11 ²⁾ | | 5827-A1x |
| | 5825-15 | | 5827-E1x |
| | 5825-20 | | 5827-A2x |
| | 5825-25 | | 5827-E2x |
| | 5825-30 | | 5827-A3x |
| | 5825-35 | | 5827-E3x |

²⁾ Actuator with slower motor no longer available; replace it with an actuator with normal stroking speed.

4 Shipment and on-site transport

The work described in this chapter is to be performed only by personnel appropriately qualified to carry out such tasks.

4.1 Accepting the delivered goods

After receiving the shipment, proceed as follows:

1. Compare the shipment received with the delivery note.
2. Check the shipment for transportation damage. Report any damage to SAMSON and the forwarding agent (refer to delivery note).

4.2 Removing the packaging from the actuator

i Note

Do not remove the packaging until immediately before mounting and start-up.

1. Remove the packaging from the electric actuator.
2. Check scope of delivery.
3. Dispose of the packaging in accordance with the valid regulations.

Table 5: Scope of delivery

| |
|---|
| 1x Type 5827 Electric Actuator |
| 1x Document IP 5827-2 (Important Product Information) |

4.3 Transporting the actuator

- Protect the actuator against external influences (e.g. impact).
- Protect the actuator against moisture and dirt.
- Observe the permissible transportation temperature of –20 to +70 °C.

4.4 Lifting the actuator

Due to the low service weight, lifting equipment is not required to lift the electric actuator.

4.5 Storing the actuator

NOTICE

Risk of electric actuator damage due to improper storage.

- ⇒ Observe the storage instructions.
- ⇒ Avoid long storage times.
- ⇒ Contact SAMSON in case of different storage conditions or longer storage periods.

i Note

SAMSON recommends to regularly check the electric actuator and the prevailing storage conditions during long storage periods.

Storage instructions

- Protect the electric actuator against external influences (e.g. impact).
- Protect the electric actuator against moisture and dirt.
- Make sure that the ambient air is free of acids or other corrosive media.
- Observe the permissible storage temperature from –20 to +70 °C.
- Do not place any objects on the electric actuator.

5 Installation

The work described in this chapter is to be performed only by personnel appropriately qualified to carry out such tasks.

5.1 Installation conditions

Work position

If not described otherwise in the valve documentation, the work position for the control valve is the front view looking onto the operating controls.

Point of installation

The electric actuator must only be used indoors.

Mounting position

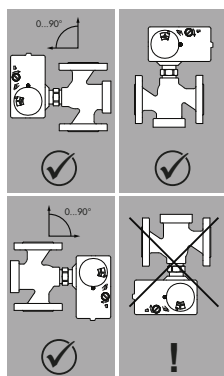

Fig. 5: Mounting position

The control valve can be installed in the pipeline in any desired position. However, a suspended mounting position of the actuator is not permissible.

NOTICE

Risk of actuator damage or malfunction due to adverse weather conditions.

⇒ Do not install the actuator outdoors.

5.2 Preparation for installation

Before installation, make sure the following conditions are met:

- The actuator is not damaged.

Proceed as follows:

⇒ Lay out the necessary material and tools to have them ready during installation work.

- Flat-blade screwdriver with 0.8 mm blade thickness and 4.0 mm blade width
- Open-end wrench with width A/F 32

Opening the front housing cover

The front housing cover of the actuator is secured by a quarter-turn fastener (see Fig. 6).

- ⇒ Use a screwdriver to turn the quarter-turn fastener to the unlock symbol.
- ⇒ Lift off the cover at the tab on the side of housing cover.



Fig. 6: Quarter-turn fastener

NOTICE

Risk of actuator damage due to unauthorized opening of the back housing cover.

⇒ Do not open the back housing cover.

5.3 Aligning the travel indication scale

The travel indication scale has two opposed scales. Which scale is to be used depends on the valve version. In the delivered state, the scale alignment applies to globe valves and three-way diverting valves.

⇒ Change the alignment when a three-way mixing valve is used.

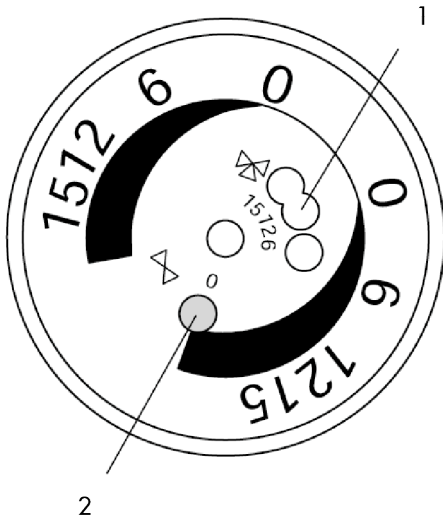

Fig. 7: Travel indication scale

- 1 Hole for driving pin with three-way mixing valve
- 2 Driving pin in position 0, location of scale with globe or three-way diverting valves (delivered state)

Globe and three-way diverting valves:

The driving pin is in position 0 (delivered state).

Three-way mixing valve:

- ⇒ Carefully open the front housing cover.
- ⇒ Remove scale, turn it and replace it so that the pin is positioned over the appropriate hole (6, 12 or 15) corresponding to the rated travel (6, 12 or 15 mm travel).

Closing the front housing cover

1. Position the front housing cover correctly and place it on the housing.
- ⇒ Make sure that the quarter-turn fastener is turned to the unlocked position (see Fig. 6) and the handwheel (actuators without fail-safe action) engages in the actuating shaft.
2. Turn the quarter-turn fastener to the locked position.

5.4 Mounting the actuator

The actuator is mounted either directly onto the valve or using a yoke depending on the valve version used (see Fig. 8 and Fig. 9).

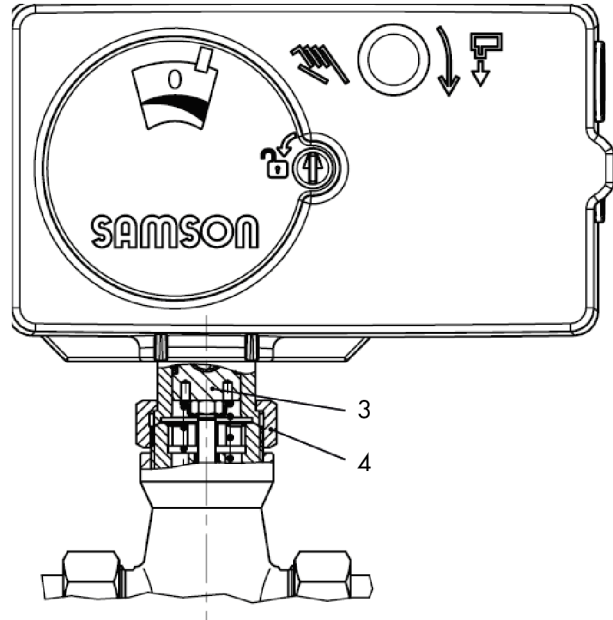

Fig. 8: Force-locking attachment with coupling nut, e.g. to Type 3222 Valve

- 3 Actuator stem with actuator piston
- 4 Coupling nut

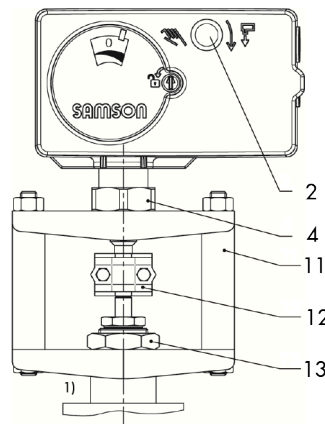

Fig. 9: Form-fit attachment with stem connector, e.g. with yoke on the valve

- 1) A spacer (accessories) is required here to mount a Type 3323 Three-way Valve (DN 65 to 80).
- 2 Handwheel
- 4 Coupling nut
- 11 Yoke
- 12 Stem connector
- 13 Hex nut

NOTICE

Risk of damage to the actuator by moving the actuator stem too far.

⇒ Move the actuator stem only as far as the bottom or top end position.

5.4.1 Actuator without fail-safe action

Force-locking attachment (see Fig. 8)

1. Turn the handwheel (2) counterclockwise to retract the actuator stem.
2. Place the actuator on the valve connection. Thread on and tighten the coupling nut (4).

| | |
|-------------------|-------|
| Tightening torque | 20 Nm |
|-------------------|-------|

Form-fit attachment (see Fig. 9)

1. Place the actuator on the yoke. Thread on and tighten the coupling nut (4).

| | |
|-------------------|-------|
| Tightening torque | 20 Nm |
|-------------------|-------|

2. Place actuator with yoke (11) on the valve. Thread on and tighten the nut (13).

| | |
|-------------------|--------|
| Tightening torque | 150 Nm |
|-------------------|--------|

Note

A spacer (see Chapter 17) is required to mount a Type 3323 Three-way Valve (DN 65 to 80).

3. Pull plug stem until it reaches the actuator stem or extend actuator stem using the handwheel (2).
4. Position the clamps of the stem connector (12) included in the accessories on the ends of the actuator stem and plug stem. Fasten tight with screws.

5.4.2 Actuator with fail-safe action

Force-locking attachment (see Fig. 8)

“Actuator stem extends” fail-safe action

The actuator stem must be retracted before the actuator can be mounted onto the valve. The stem can be retracted either mechanically or electrically. Both methods are described below.

Retracting the actuator stem mechanically

1. Unfasten the front housing cover and place a 4 mm Allen key on the red actuating shaft.
2. Retract the actuator stem: Turn Allen key counterclockwise and only as far as the top end position which is at the point where the torque switch is activated (see Chapter 6).
3. Hold Allen key in place. Thread on and tighten the coupling nut.

| | |
|-------------------|-------|
| Tightening torque | 20 Nm |
|-------------------|-------|

4. Remove Allen key and carefully replace the front housing cover.

Retracting the actuator stem electrically

1. Remove the front housing cover.
2. Perform electrical wiring as described in Chapter 5.6 and carefully replace the front housing cover.
3. Retract the actuator stem: Apply the supply voltage and retract the actuator stem electrically until it reaches the end position by applying a signal to the input (see Chapter 8).

To proceed, connect the output terminals of a controller to the input terminals of the electric actuator. Set the controller's output signal to 10 V or 20 mA depending on the type of signal (see Chapter 5.6).

NOTICE

Risk of damage to the electric actuator due to incorrect connection of the voltage.

The electric actuator has terminals to retract the stem (eL terminal) and to extend the stem (aL terminal).

- ⇒ Do not apply a voltage to eL and aL terminals at the same time.
- ⇒ Make sure that single wires of multi-core or fine-stranded conductors do not touch neighboring terminals.

4. Thread on and tighten the coupling nut.

“Actuator stem retracts” fail-safe action

- ⇒ Place the actuator on the valve connection and fasten with the coupling nut.

| | |
|-------------------|-------|
| Tightening torque | 20 Nm |
|-------------------|-------|

Installation

Form-fit attachment

- ⇒ Mount the actuator as described in Chapter 5.4.1.

5.5 Installing the control valve into the pipeline

ⓘ NOTICE

Risk of actuator damage or malfunction due to adverse weather conditions.

- ⇒ Do not install the actuator outdoors.

ⓘ NOTICE

Degree of protection not achieved due to incorrect mounting position.

- ⇒ Do not install the valve with the actuator suspended downwards (see Chapter 5.1).

ⓘ NOTICE

Risk of actuator damage due to direct contact with steam.

- ⇒ Make sure that a mounted actuator cannot come into contact with a jet of steam while the control valve is in operation.

- ⇒ Install the valve into the pipeline according to the specifications in the mounting and operating instructions of the valve.

5.6 Electrical connection

⚠ DANGER

Risk of fatal injury due to electric shock.

- ⇒ Upon installation of the electric cables, you are required to observe the regulations concerning low-voltage installations according to DIN VDE 0100 as well as the technical connection requirements of your local energy supplier.
- ⇒ Observe the relevant electrotechnical regulations of the country of use as well as the technical connection requirements of the grid operator in charge.
- ⇒ Before connecting wiring, performing any work on the device or opening the device, disconnect the supply voltage and protect it against unintentional reconnection.

- ⇒ Use a suitable voltage supply which does not allow any dangerous voltage to reach the device in normal operation or in the event of a malfunction in the system or any other system parts.

- ⇒ Only perform the electrical connection after disconnecting the supply voltage. Make sure the supply voltage cannot be reconnected unintentionally.

- ⇒ Use approved cable glands with cable grip at the cable entry.

- ⇒ Only use protective equipment that can be protected against unintentional reconnection of the power supply.

- ⇒ Do not remove any covers to perform adjustment work on live parts.

ⓘ NOTICE

Risk of actuator damage due to incorrect wiring of the inputs.

- ⇒ Wire the inputs according to the technical data (see Chapter 3.6).

ⓘ NOTICE

Risk of actuator damage due to a short circuit.

The supply voltage as well as the input and output signals are not galvanically isolated from one another.

- ⇒ Do not apply any external voltage.

- ⇒ Do not connect terminals with each other.

- ⇒ Make sure that the single wires of multi-core conductors do not touch neighboring terminals.

Wiring

- ⇒ Mount approved cable glands with cable grip.

- ⇒ Guide the connecting cables through the cable gland into the housing and connect as shown in Fig. 10.

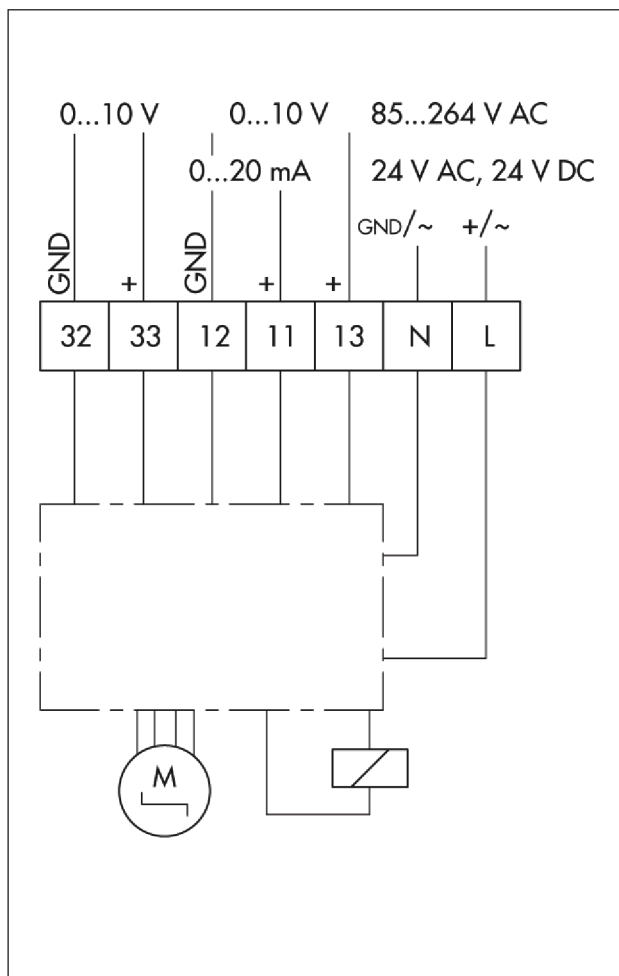

Fig. 10: Electrical connection · Positioner

i Note

The 24 V version can be used either with a supply voltage of 24 V AC or 24 V DC.

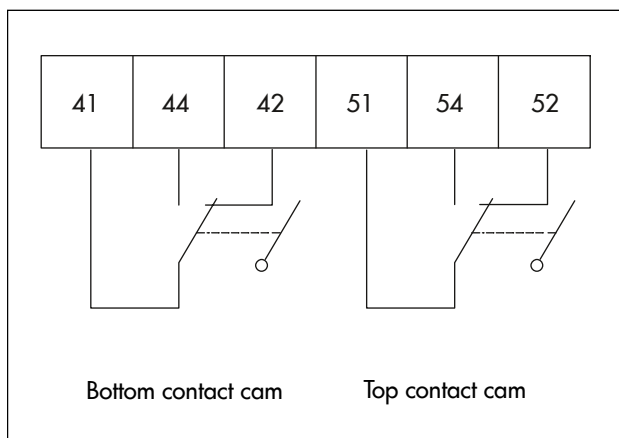

Fig. 11: Electrical connection · Limit contacts

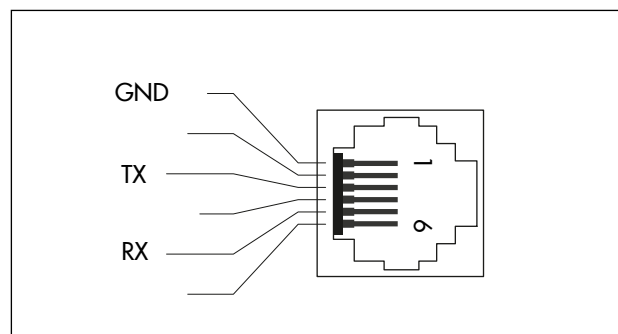

Fig. 12: Assignment of the RJ-12 jack

Table 6: Cables and stranded wires that can be used

| Cable | Wire cross-section |
|---|------------------------------|
| With terminals for control and supply | |
| Single-wire H05(07) V-U | 0.5 to 1.5 mm ² |
| Fine-wire H05(07) V-K | 0.5 to 1.5 mm ² |
| Length of insulation to be stripped off wire ends: 6 mm (±0.5 mm) | |
| With terminals for limit contacts | |
| Single-wire H05(07) V-U | 0.2 to 1.5 mm ² |
| Fine-wire H05(07) V-K | 0.2 to 1.5 mm ² |
| With wire ferrule according to DIN 46228-1 | 0.25 to 1.5 mm ² |
| With wire ferrule with collar according to DIN 46228-4 | 0.25 to 0.75 mm ² |
| Length of insulation to be stripped off wire ends: 8 mm | |

6 Operation

6.1 Device overview and operating controls



Fig. 13: Location of operating elements

- 1 Travel indication scale
- 2 Handwheel (only without fail-safe action)

NOTICE

Specified degree of protection does not apply when the housing cover is open.

⇒ Ensure that no moisture or foreign particles can get into the actuator.

6.1.1 LED indication

The actuator has a red and a yellow LED which indicate the operating state of the actuator through a blinking pattern. The LEDs are located underneath the front housing cover of the actuator.

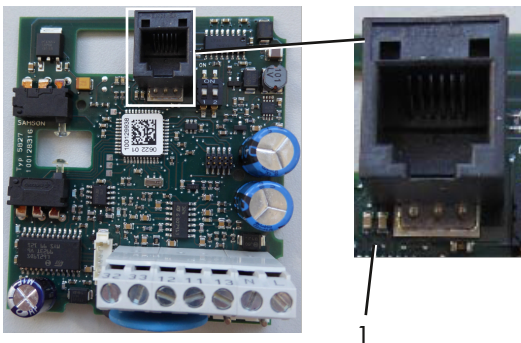

Fig. 14: Location of LEDs (24 V version)

- 1 LEDs (red and yellow)

Note

The latest 24 V version of the electric actuator is shown in Fig. 14. The images and descriptions that apply to previous versions of the actuator are included in Appendix A.

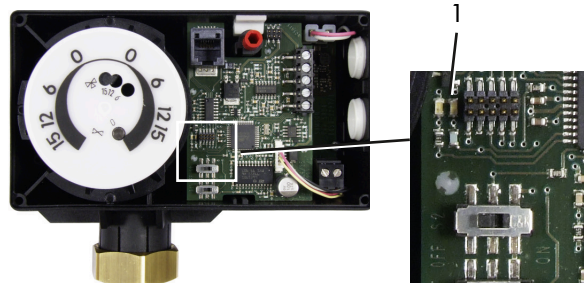

Fig. 15: Location of LEDs (85 to 264 V version)

- 1 LEDs (red and yellow)

6.1.2 Function switch

The function switch has the following functions:

1. Determine the input signal range
2. Start initialization (see Chapter 7)

Switch position 1 or A (default):

- Input signal 0 to 10 V or 0 to 20 mA
- Input signal settings in TROVIS-VIEW override the switch positions.

Switch position ON or B:

- Input signal 2 to 10 V or 4 to 20 mA
- Input signal settings in TROVIS-VIEW are ignored.

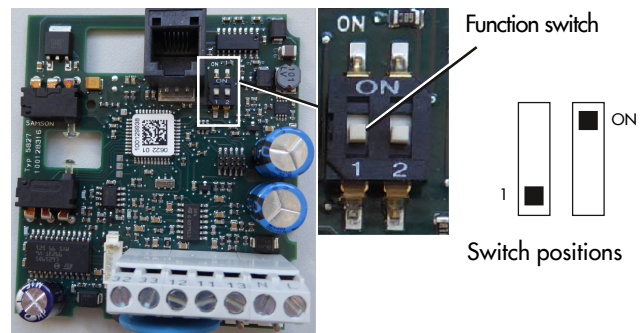

Fig. 16: Function switch (24 V version)

i Note

The latest 24 V version of the electric actuator is shown in Fig. 16. The images and descriptions that apply to previous versions of the actuator are included in Chapter 16.

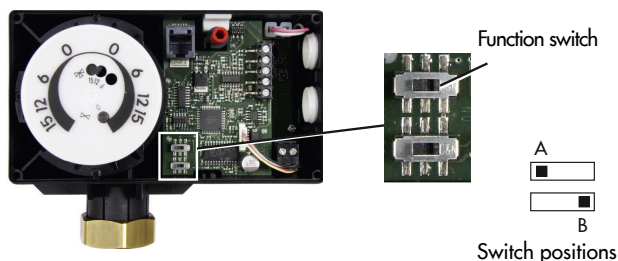

Fig. 17: Function switch (85 to 264 V version)

6.1.3 Operating direction switch

The position of the operating direction switch determines the actuator's direction of action.

Switch position 2 or A (default):

- Direction of action increasing/increasing >>
The actuator stem retracts as the input signal increases.

Switch position ON or B:

- Direction of action increasing/decreasing <<
The actuator stem extends as the input signal increases.

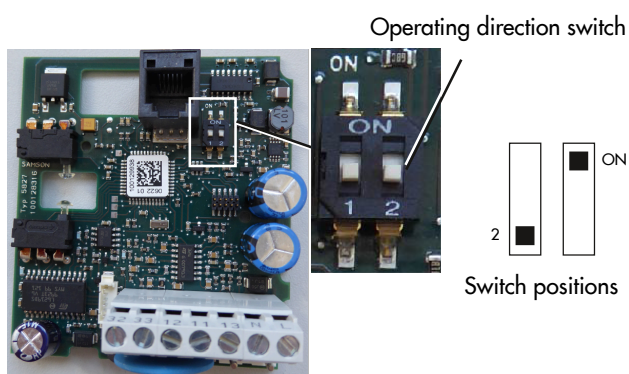

Fig. 18: Operating direction switch (24 V version)

i Note

The latest 24 V version of the electric actuator is shown in Fig. 18. The images and descriptions that apply to previous versions of the actuator are included in Chapter 16.

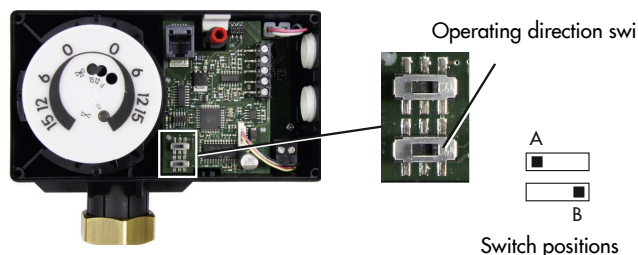

Fig. 19: Operating direction switch (85 to 264 V version)

6.1.4 Actuating shaft (opened front housing cover)

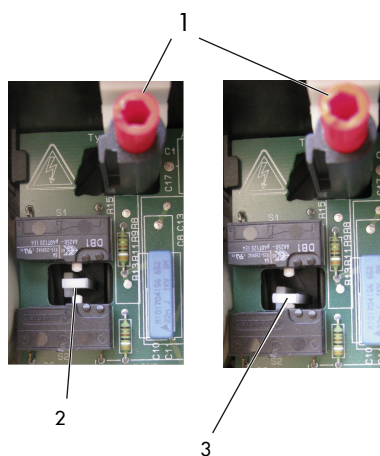

Fig. 20: Actuating shaft and torque switches

- 1 Actuating shaft
- 2 Tag in neutral position
- 3 Tag when the end position is reached (torque switch triggered)

7 Start-up and configuration

7.1 Initializing the actuator

To achieve correct position feedback, the actuator must be initialized. This is also necessary after changing the configuration at the actuator. The actuator can be initialized at the actuator itself or using the TROVIS-VIEW software.

⚠ DANGER

Risk of fatal injury due to electric shock from exposed live parts.

⇒ Do not touch live parts.

⚠ WARNING

Risk of injury due to the actuator stem extending or retracting (with form-fit attachment).

Directly after connecting the supply voltage, the actuator stem can start to move.

⇒ Do not touch or block the actuator stem.

ⓘ NOTICE

The process is disturbed by the movement of the actuator stem.

⇒ Do not perform zero calibration or initialization while the process is running. First isolate the plant by closing the shut-off valves.

Start initialization:

1. Open the front housing cover.
2. Place the function switch into the required position.
3. Switch the function switch briefly back and forth between positions (see Fig. 21 and Fig. 22).

The red LED indicates that initialization is in progress (see Fig. 21).

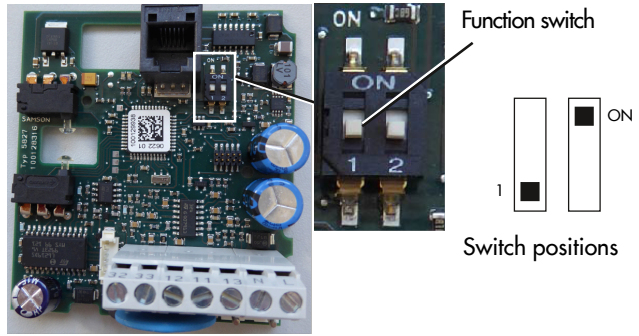

Fig. 21: Function switch (24 V version)

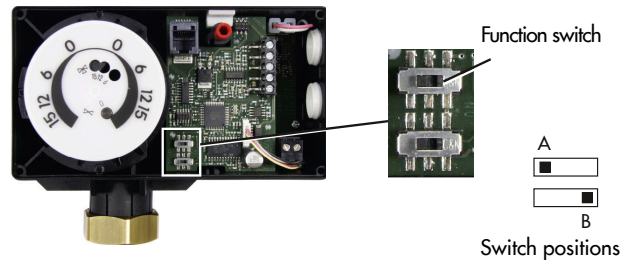

Fig. 22: Function switch (85 to 264 V version)

ⓘ NOTICE

Risk of malfunction due to incomplete or incorrect start-up.

⇒ Start initialization.

⇒ Initialization has been completed when the red LED turns off.

The actuator is not ready to use until initialization is completed.

i Note

The actuator automatically performs a zero calibration as soon as the supply voltage is applied to the L and N terminals. This is indicated by the red LED blinking (see Chapter 8). This function does not replace the initialization procedure.

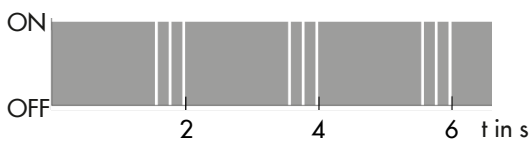

Fig. 23: Blinking pattern of the red LED (initialization in progress):

7.2 Configuring the actuator

The actuator is configured with the TROVIS-VIEW software (see Chapter 16). In this case, the serial interface on the actuator is used to connect the actuator to the computer (see Chapter 3).

⚠ DANGER

Risk of fatal injury due to electric shock from exposed live parts.

⇒ Do not touch live parts.

⇒ More details on settings and operation with TROVIS-VIEW can be found in ► EB 6661.

7.3 Adjusting the limit contacts

⚠ DANGER

Risk of fatal injury due to electric shock.

⇒ Before opening the housing cover, disconnect the supply voltage and protect it against unintentional reconnection.

⇒ Disconnect the signal line.

i Note

Limit contacts are not suitable for retrofitting.

The limit contacts can optionally be used as make or break contacts (see Chapter 3).

Terminal assignment

⇒ See Chapter 5.

Terminals 41, 44, 42:

- Bottom cam disk, adjuster 7.1

Terminals 51, 54, 52:

- Top cam disk, adjuster 7.2

1. Remove the front housing cover.
2. Move the actuator stem to the position at which switching point is to be activated.
3. Use a 4 mm Allen key to turn the adjusters up to the point where the contact is triggered (see Chapter 3).

💡 Tip

The angle of rotation of the cam disks is limited. Therefore, use preferably the adjuster (7.1) for the lower travel range and the adjuster (7.2) for the upper travel range (see Fig. 24).

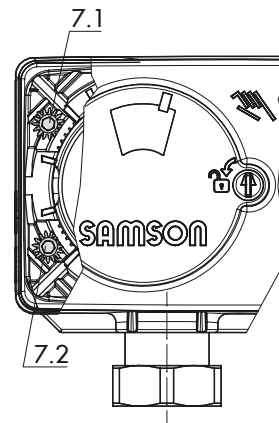

Fig. 24: Adjusters for limit contacts

7.1 Adjuster for limit contact (bottom contact cam)

7.2 Adjuster for limit contact (top contact cam)

Start-up and configuration

Switching point of the lower limit contact

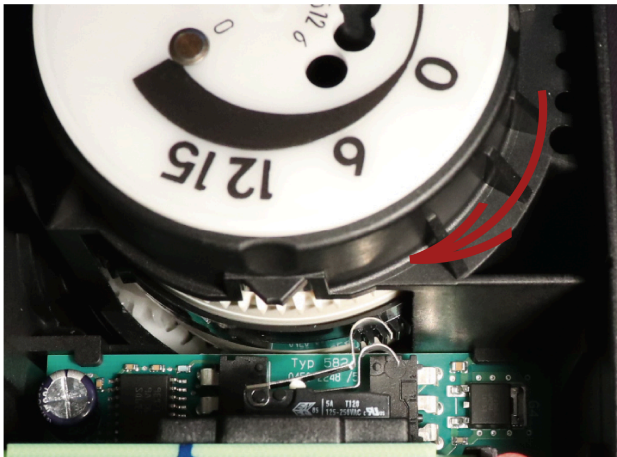

- Activated by the bottom cam disk at 0 % travel when moving in the direction indicated by the arrow
- Lower limit contact is active when the actuator stem is extended.
- Adjustable with adjuster 7.1
- Contacts 41/44 closed when the switch is active

Switching point of the upper limit contact

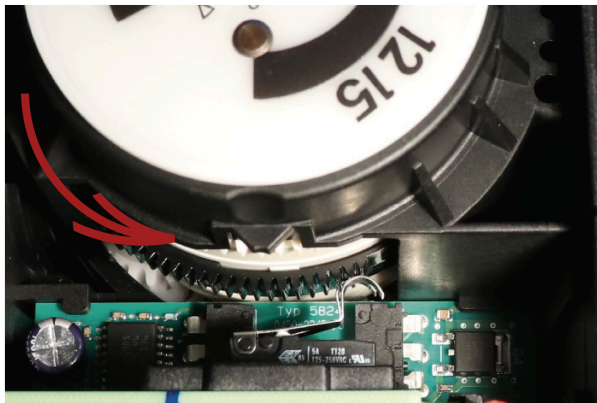

- Activated by the top cam disk at 100 % travel when moving in the direction indicated by the arrow
- Upper limit contact is active when the actuator stem is retracted.
- Adjustable with adjuster 7.2
- Contacts 51/54 closed when the switch is active

Limit contacts inactive

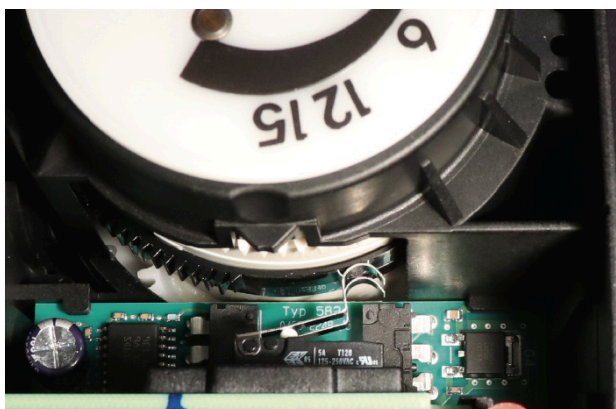

- Not activated by the cam disks
- Both limit contacts inactive
- Contacts 41/42 closed (lower limit contact)
- Contacts 51/52 closed (upper limit contact)

8 Setup

After connecting the supply voltage, the actuator is ready for use.

8.1 Positioner

The actuator stem's position directly follows the input signal.

8.2 LED blinking pattern

Explanations to the blinking pattern of the LEDs

The ON/OFF state of the corresponding LED is shown over time.

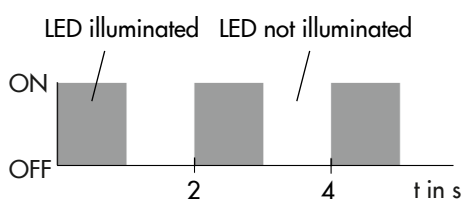

Blinking pattern of the yellow LED

Device ON

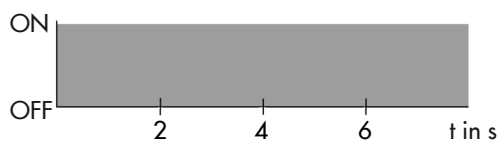

Stem position relative

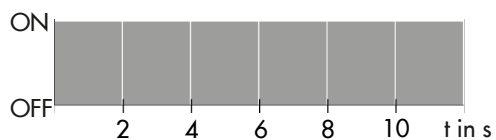

Blocking protection in progress

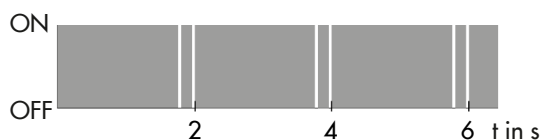

Blinking pattern of the red LED

Device starting up

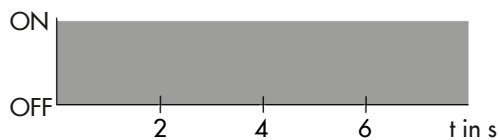

Zero calibration in progress

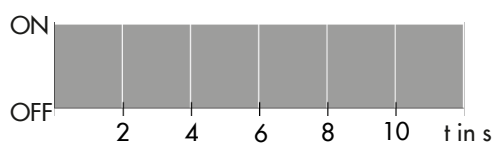

Setup

Transit time measurement in progress

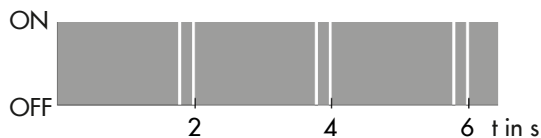

Initialization in progress

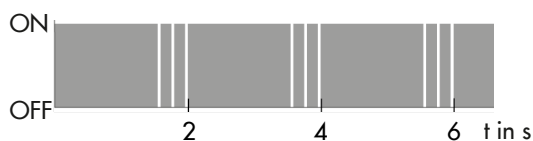

i Note

The LED blinking patterns apply when the memory pen is inserted into the actuator (see Chapter 8.4).

8.3 Manual mode

The actuator stem can be moved mechanically or alternatively electrically in the manual level in TRO-VIS-VIEW (► EB 6661).

Direction of action and travel can be read off the scale.

⚠ DANGER

Risk of fatal injury due to electric shock.

- ⇒ Before opening the housing cover, disconnect the supply voltage and protect it against unintentional reconnection.
- ⇒ Disconnect the signal line.

⚠ DANGER

Risk of fatal injury due to electric shock from exposed live parts.

- ⇒ Do not touch live parts.

ⓘ NOTICE

Specified degree of protection does not apply when the housing cover is open.

- ⇒ Ensure that no moisture or foreign particles can get into the actuator.

ⓘ NOTICE

Risk of damage to the actuator by moving the actuator stem too far.

- ⇒ Move the actuator stem only as far as the bottom or top end position.

8.3.1 Mechanical override

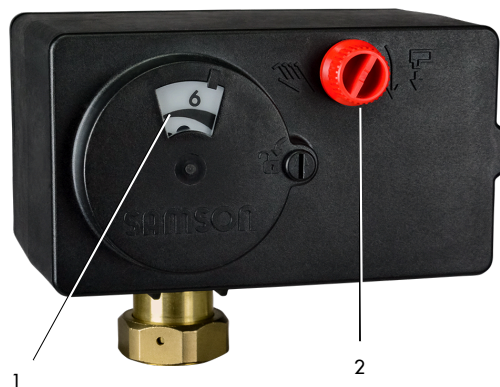

Fig. 25: Location of operating elements

- 1 Travel indication scale
- 2 Handwheel (only without fail-safe action)

Turning direction

- Turn clockwise: The actuator stem extends.
- Turn counterclockwise: The actuator stem retracts.

| Turning direction | Direction the actuator stem movement |
|-------------------|--------------------------------------|
| | Extends |
| | Retracts |

ⓘ NOTICE

Risk of damage to the actuator by moving the actuator stem too far.

- ⇒ Move the actuator stem only as far as the bottom or top end position.

NOTICE**Risk of malfunction due to incorrect calibration values.**

The positioning of the valve is affected when the handwheel is operated while the process is running. As a result, zero point and the position feedback do not match the calibrated values.

- ⇒ Perform a new zero calibration.
- ⇒ Re-initialize or perform a new transit time measurement.

Actuator without fail-safe action

To move the actuator stem manually one millimeter, the handwheel must be turned approx. four turns.

Actuator with fail-safe action

For actuators with fail-safe action, move the actuator stem one millimeter manually by turning the actuating shaft approx. four turns using a 4 mm Allen key. The front housing cover must be opened first (see Chapter 5).

DANGER**Risk of fatal injury due to electric shock.**

- ⇒ Before opening the housing cover, disconnect the supply voltage and protect it against unintentional reconnection.
- ⇒ Disconnect the signal line.

1. Remove the front housing cover and place a 4 mm Allen key on the red actuating shaft.
2. Use the Allen key to turn the actuating shaft:
 - ▶ Turn it counterclockwise only for actuators with "actuator stem extends" fail-safe action.
 - ▶ Turn it clockwise only for actuators with "actuator stem retracts" fail-safe action.
3. Turn the Allen key only as far as the final travel value, which is at the point where the torque switch is activated.

Once the magnet has been released, the spring mechanism pushes the actuator stem back to the fail-safe position.

4. Remove Allen key and carefully replace the front housing cover.



Fig. 26: Types 5827-Axx and 5827-Exx Electric Actuators

8.4 Operation using memory pen**NOTICE****Specified degree of protection does not apply when the housing cover is open.**

- ⇒ Ensure that no moisture or foreign particles can get into the actuator.

- ⇒ See ► EB 6661.

The memory pen can be loaded with data configured in TROVIS-VIEW and the configuration data transferred to one or several devices of the same type and version. Additionally, the data from the device can be written to the memory pen. This allows the configuration data to be simply copied from one device and loaded onto other devices of the same type and version. The data logging function also allows operating data to be recorded.

The memory pen can be configured in TROVIS-VIEW. The following functions for the actuator can be selected:

- Read data from the memory pen
- Write data to the memory pen
- Time-controlled data logging
- Event-triggered data logging
- Command mode

Refer to the operating instructions for TROVIS-VIEW ► EB 6661 for details on how to configure the memory pen.

Setup

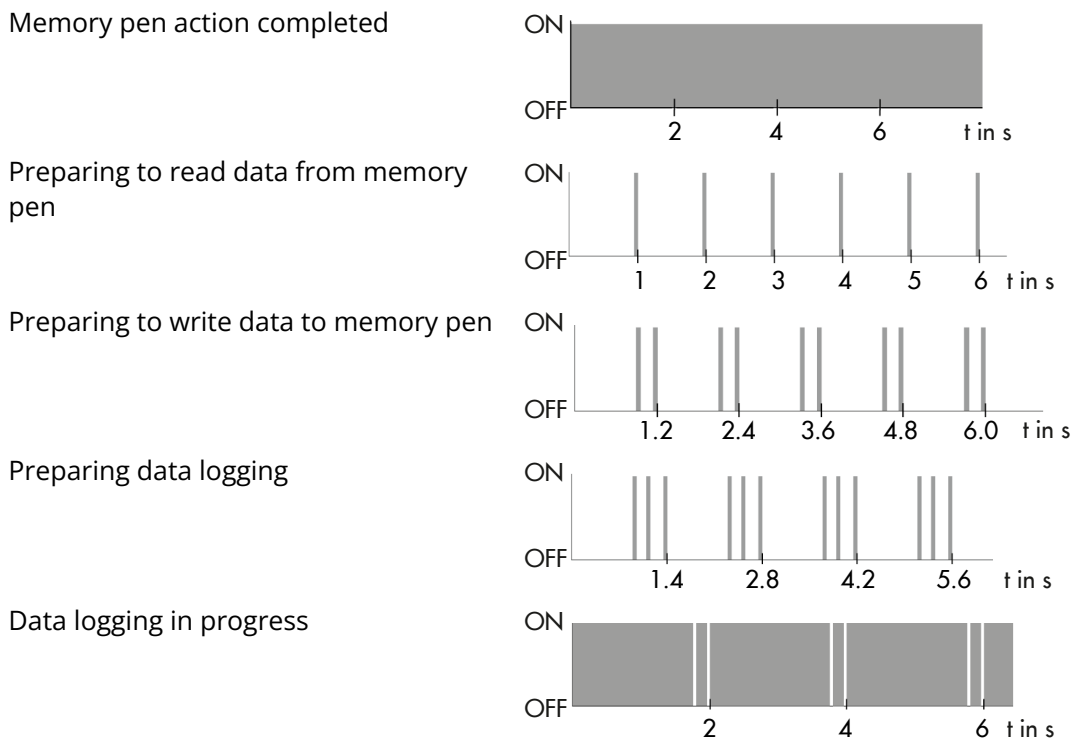

Fig. 27: Memory pen-64

i Note

On inserting a memory pen that is empty or contains data from another type of device or another version of the same device into the serial interface port of the device, the data from the device are uploaded onto the memory pen regardless of the status of the memory pen.

LED blinking pattern for the memory pen



Data transmission between the actuator and memory pen

The memory pen is connected to the actuator as shown in Fig. 28. The TROVIS-VIEW Operating Instructions ► EB 6661 describe how to transfer data.

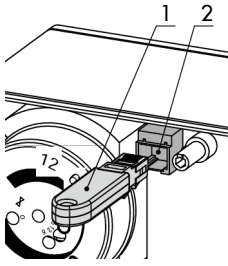

Fig. 28: Connecting actuator and memory pen

- 1 Memory pen
- 2 Serial interface (RJ12 port)

The yellow LED on the actuator indicates that the data transfer from the device is being prepared. Data transmission is completed as soon as the yellow LED is illuminated continuously (see Chapter 6).

8.4.1 Copying function

The data can be transferred to another actuator of the same type after the data from the actuator are written to the memory pen.

i Note

'Automatically write to memory pen' is automatically reset to the read status after data are transferred from the actuator for the first time.

8.4.2 Data logging

The memory pen-64 allows the following data to be saved:

- Input in %
- Actuator travel in %
- Position feedback in %
- Temperature inside device in °C
- Torque switch: Actuator stem retracted
- Torque switch: Actuator stem extended
- Position feedback is relative
- Error during operation
- Input signal failure
- Position of the operating direction switch
- Position of the function switch

The data are logged until the memory capacity of the memory pen is full.

Data in the memory pen can be saved to a data logging file using the TROVIS-VIEW software.

Data logging

1. Plug the memory pen into the serial interface of the actuator (see Fig. 28). The yellow LED on the actuator indicates that the data logging is being prepared (see Chapter 8.4). A change in the blinking pattern of the yellow LED indicates that data are being saved to the memory pen.
2. Data logging is completed by removing the memory pen from the serial interface of the actuator.

i Note

You can load a data logging file into the Trend-Viewer by selecting the 'Load diagram ...' command in TROVIS-VIEW.

Transferring data onto a computer

1. Insert the memory pen together with modular adapter into the serial interface (COM port) of the computer (see Chapter 17).
2. Select 'Read logged Data...' from the 'Memory pen' menu.
3. Select the desired target directory. If the target directory is not changed, data will be saved in the SAMSON folder > Type 5827.
4. Enter the file name.
5. Click 'Save' button to start data transmission.

8.4.3 Command mode

In closed-loop operation, the actuator stem can be moved to the top or bottom end position using the command pen regardless of the input signal. Data are written to the command pen using TROVIS-VIEW.

Possible settings:

- Retract actuator stem
- Extend actuator stem
- No movement of the actuator stem

These commands turn a memory pen into a command pen. After inserting the command pen into the actuator's interface, all functions running are ended and the command is executed. A command pen has priority over all functions.

i Note

The fail-safe action always has priority in actuators with fail-safe action. In this case the command function has a lower priority.

i Note

- *A command pen remains active as long as it is inserted into the actuator's interface (even after a reset).*
 - *Only one command at a time can be written to the memory pen and executed.*
-

8.5 Readings in TROVIS-VIEW

8.5.1 Operating values

i Note

The values in the 'Operating values' folder cannot be changed.

In online mode, the current operating values are listed in the 'Operating values' folder. Based on the setting, a graph plotting these values is also shown under the 'Operating values' window.

| | |
|------------------------|---|
| Measured values | Positioning value in % Input signal in V |
| Outputs | Calculated actuator travel in % Calculated actuator travel in mm Position feedback in % Position feedback in V Set point deviation in % |
| Limit contact | Actuator stem retracted Actuator stem extended |
| Switch | Operating direction switch Function switch |

8.5.2 Operating states

Error messages can be read in the 'Service' folder (> 'Operating states').

i Note

Operating states and errors are also indicated by the LEDs (see Chapter 8.2).

| | |
|-------------------------|-------------------------------|
| Operating states | Operating states Functions |
|-------------------------|-------------------------------|

8.5.3 Functions

In the 'Service' folder ('Functions'), the following functions are shown:

| | |
|-----------------------|--|
| Manual level | ⇒ Manual level |
| Functions | ⇒ Perform reset ⇒ Load default settings in actuator ⇒ Start zero calibration ⇒ Start transit time measurement Measured transit time in s Speed during measurement |
| Basic settings | Rated actuator travel in mm Select new rated travel in mm ⇒ Transmit new basic settings |

The functions can be executed when communication between the actuator and computer is established.

8.5.4 Status messages

In the 'Service' folder (> 'Status messages'), the following parameters are shown:

| | |
|-------------------------|--|
| Device | Firmware version Serial number Device designation Manufacturing parameters |
| Operation | Operating hours in h Operating hours at excess temperature in h Temperature inside device in °C Highest temperature inside device in °C Lowest temperature inside device in °C |
| Actuator strokes | Motor running time in h Starts Changes in direction |
| Valve strokes | Full travel cycles |
| LEDs | Yellow (operation) Red (error) |

8.5.5 Statistics

In the 'Service' folder (> 'Statistics'), the following parameters are shown:

| | |
|----------------------------------|--|
| Device failures counters | Power supply activated Program interruptions Limit contact error EEPROM error |
| Alarms counters | Input signal failures |
| Counter: switch | Operating direction switch Function switch Initialization |
| Counter: manual overrides | Manual overrides |
| Memory pen counters | Command: retract actuator stem Command: extend actuator stem Data read Data written Data logged |
| Functions counter | Basic settings changed Configuration changed Manual level activated Zero calibration started Initialization started Reset triggered Default settings loaded Transit time measurement started Calibration changed |

9 Malfunctions

9.1 Troubleshooting

⇒ See Table 7.

i Note

Contact SAMSON's After-sales Service for malfunctions not listed in the table.

Table 7: Troubleshooting

| Malfunction | Possible reasons | Recommended action |
|--|--|---|
| Actuator stem does not move. | Actuator is blocked. | ⇒ Check attachment. ⇒ Remove the blockage. |
| | No or incorrect supply voltage connected. | ⇒ Check the supply voltage and connections. |
| Actuator stem does not move through the whole range. | No or incorrect supply voltage connected. | ⇒ Check the supply voltage and connections. |
| The actuator does not control the valve position. | The actuator was not initialized or not correctly initialized during start-up. | ⇒ Check the switch position of the function and direction of action switches (see Chapter 6.1.2 and Chapter 6.1.3). |
| | The mounting has been changed. | ⇒ Initialize the actuator. |

9.2 Error indication by LEDs

Blinking pattern of the yellow LED

Plausibility error in memory pen

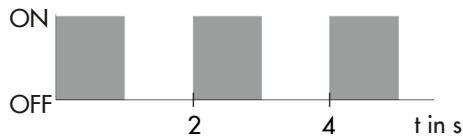

EEPROM error in memory pen

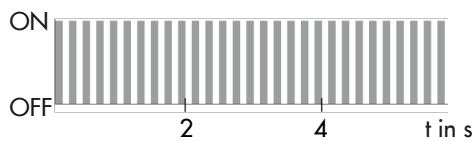

Blinking pattern of the red LED

Limit contact error

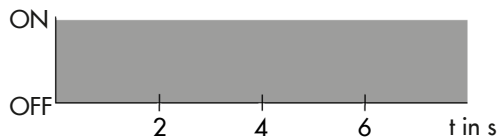

Input signal failure detected

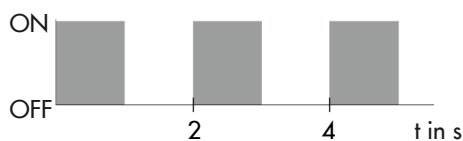

EEPROM error

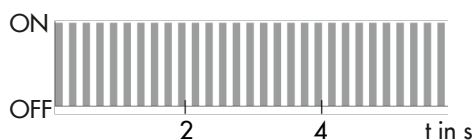

9.3 Emergency action

The valve, on which the electric actuator with fail-safe action is mounted, is moved to its fail-safe position upon supply voltage failure (see Chapter 3).

Plant operators are responsible for emergency action to be taken in the plant.



Tip
Emergency action in the event of valve failure is described in the associated valve documentation.

10 Servicing

The work described in this chapter is to be performed only by personnel appropriately qualified to carry out such tasks.

i Note

The electric actuator was checked by SAMSON before it left the factory.

- *The product warranty becomes void if service or repair work not described in these instructions is performed without prior agreement by SAMSON's After-sales Service.*
-

The actuator requires no maintenance.

SAMSON recommends inspection and testing according to the following table:

Table 8: *Recommended inspection and testing*

| Inspection and testing | Action to be taken in the event of a negative result |
|---|---|
| Check the markings, labels and nameplates on the device for their readability and completeness. | ⇒ Immediately renew damaged, missing or incorrect nameplates or labels. ⇒ Clean any inscriptions that are covered with dirt and are illegible. |
| Check the electric wiring. | ⇒ Tighten any loose terminal screws (see Chapter 5.6). ⇒ Renew damaged wires. |

11 Decommissioning

The work described in this chapter is to be performed only by personnel appropriately qualified to carry out such tasks.

⚠ DANGER

Risk of fatal injury due to electric shock.

- ⇒ *Before disconnecting live wires at the device, disconnect the supply voltage and protect it against unintentional reconnection.*
-

⚠ WARNING

Risk of personal injury due to residual process medium in the valve.

While working on the valve, residual medium can flow out of the valve and, depending on its properties, cause personal injury, e.g. (chemical) burns.

- ⇒ *Wear protective clothing, safety gloves and eye protection.*
-

⚠ WARNING

Risk of burn injuries due to hot or cold components and pipeline.

Valve components and the pipeline may become very hot or cold. Risk of burn injuries if touched.

- ⇒ *Allow components and pipeline to cool down or warm up to ambient temperature.*
 - ⇒ *Wear protective clothing and gloves.*
-

To put the electric actuator out of operation for repair work or disassembly, proceed as follows:

- ⇒ Put the control valve out of operation (see associated valve documentation).
 - ⇒ Disconnect the supply voltage and protect it against unintentional reconnection.
 - ⇒ Make sure that a signal from the controller cannot act upon the actuator.
-

i Note

Actuator with fail-safe action move to the defined fail-safe position after the supply voltage is switched off.

12 Removal

The work described in this chapter is to be performed only by personnel appropriately qualified to carry out such tasks.

⚠ DANGER

Risk of fatal injury due to electric shock.

⇒ Before disconnecting live wires at the device, disconnect the supply voltage and protect it against unintentional reconnection.

⚠ WARNING

Risk of personal injury due to hot components.

⇒ If necessary, allow the pipeline and valve components to cool down.

⚠ WARNING

Risk of personal injury due to residual process medium in the valve.

While working on the valve, residual medium can flow out of the valve and, depending on its properties, cause personal injury, e.g. (chemical) burns.

⇒ Wear protective clothing, safety gloves and eye protection.

12.1 Force-locking attachment

⇒ See Fig. 29.

Version without fail-safe action

1. Retract the actuator stem using the handwheel (see Chapter 8).
2. Open the front housing cover.
3. Disconnect the conductors from the terminals and remove the connecting cable.
4. Undo the coupling nut (4) and remove the actuator from the valve connection.

Version with “actuator stem extends” fail-safe action

1. Open the front housing cover.
2. Disconnect the conductors from the terminals and remove the connecting cable.
3. Retract the actuator stem with a 4 mm Allen key (see Chapter 8).

Hold the actuating shaft in place after retracting the actuator stem to prevent it from extending again.

4. Undo the coupling nut (4) and remove the actuator from the valve connection.

Version with “actuator stem retracts” fail-safe action

⇒ Proceed as for the version without fail-safe action.

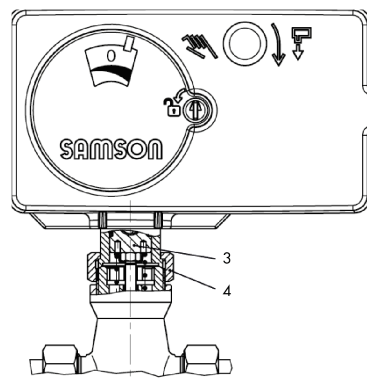

Fig. 29: Force-locking attachment with coupling nut, e.g. to Type 3222 Valve

- 3 Actuator stem with actuator piston
- 4 Coupling nut

12.2 Form-fit attachment

⇒ See Fig. 30.

Version without fail-safe action

1. Retract the actuator stem using the handwheel (see Chapter 8).
2. Open the front housing cover.
3. Disconnect the conductors from the terminals and remove the connecting cable.
4. Unfasten the stem connector clamps (12) between the actuator stem and the plug stem.
5. Undo the nut (13) and remove the rod-type yoke (11) together with the actuator from the valve.
6. Undo the coupling nut (4) and remove the actuator from the rod-type yoke (11).

Version with “actuator stem extends” fail-safe action

1. Open the front housing cover.
2. Disconnect the conductors from the terminals and remove the connecting cable.
3. Unfasten the stem connector clamps (12) between the actuator stem and the plug stem.

Removal

4. Retract the actuator stem with a 4 mm Allen key (see Chapter 8).

Hold the actuating shaft in place after retracting the actuator stem to prevent it from extending again.

5. Undo the nut (13) and remove the rod-type yoke (11) together with the actuator from the valve.
6. Undo the coupling nut (4) and remove the actuator from the rod-type yoke (11).

Version with "actuator stem retracts" fail-safe action

⇒ Proceed as for the version without fail-safe action.

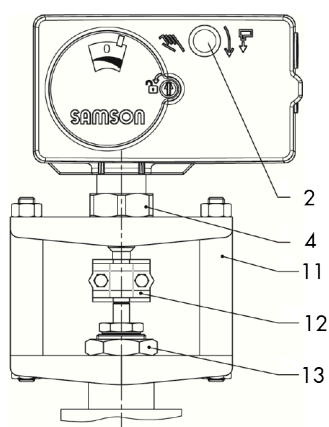

Fig. 30: Form-fit attachment with stem connector, e.g. with yoke on the valve

- | | |
|----|----------------|
| 2 | Handwheel |
| 4 | Coupling nut |
| 11 | Yoke |
| 12 | Stem connector |
| 13 | Hex nut |

13 Repair

If the actuator does not function properly according to how it was originally sized or does not function at all, it is defective and must be repaired or exchanged.

NOTICE

Risk of actuator damage due to incorrect service or repair work.

- ⇒ *Do not perform any repair work on your own.*
- ⇒ *Contact SAMSON's After-sales Service for service and repair work.*

13.1 Returning the actuator to SAMSON

Defective actuators can be returned to SAMSON for repair. Proceed as follows to return devices:

1. Remove the electric actuator from the valve (see Chapter 12).
2. Proceed as described on our website at
▶ www.samsongroup.com > SERVICE > After-sales Service > Returning goods.

14 Disposal

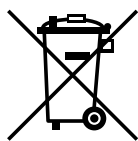

SAMSON is a producer registered in Europe, agency in charge

► www.samsongroup.com > About SAMSON > Environment, Social & Governance > Material Compliance > Waste electrical and electronic equipment (WEEE)
WEEE reg. no.: DE 62194439

Information on substances listed as substances of very high concern (SVHC) on the candidate list of the REACH regulation can be found in the document "Additional Information on Your Inquiry/Order", which is added to the order documents, if applicable. This document includes the assigned SCIP number, which can be entered into the database on the European Chemicals Agency (ECHA) website to find out more information on the SVHC ► <https://www.echa.europa.eu/scip-database>.

i Note

SAMSON can provide you with a recycling passport on request. Simply e-mail us at aftersaleservice@samsongroup.com giving details of your company address.

💡 Tip

On request, SAMSON can appoint a service provider to dismantle and recycle the product as part of a distributor take-back scheme.

-
- ⇒ Observe local, national and international refuse regulations.
 - ⇒ Do not dispose of components, lubricants and hazardous substances together with your other household waste.

15 Certificates

The following certificates are included on the next pages:

- EU declarations of conformity
- EC type examination certificate
- TR CU certificate
- Declaration of incorporation

The certificate shown was up to date at the time of publishing. The latest certificate can be found on our website at:

► www.samsongroup.com > Products > Actuators > 5827



EU Konformitätserklärung / EU Declaration of Conformity / Déclaration UE de conformité

Die alleinige Verantwortung für die Ausstellung dieser Konformitätserklärung trägt der Hersteller/
This declaration of conformity is issued under the sole responsibility of the manufacturer/
La présente déclaration de conformité est établie sous la seule responsabilité du fabricant.

Für das folgenden Produkte / For the following product/ Nous certifions que les produit

Elektrischer Antrieb / Electric Actuator / Servomoteur électrique **Typ / Type / Type 5827**

wird die Konformität mit den einschlägigen Harmonisierungsrechtsvorschriften der Union bestätigt /
the conformity with the relevant Union harmonisation legislation is declared with/
sont conformes à la législation applicable harmonisée de l'Union:

EMC 2014/30/EU

EN 61000-6-2:2005, EN 61000-6-3:2007/A1:2011

LVD 2014/35/EU

EN 60730-1:2011
EN 60730-2-14 :1997/A1 :2005/A11 :2005/A2 :2008

RoHS 2011/65/EU

EN IEC 63000:2018

Hersteller / Manufacturer / Fabricant:

SAMSON AKTIENGESELLSCHAFT
Weismüllerstraße 3
D-60314 Frankfurt am Main
Deutschland/Germany/Allemagne

Frankfurt / Francfort, 2023-01-10

Im Namen des Herstellers/ On behalf of the Manufacturer/ Au nom du fabricant.

Fabio Roma
Vice President Smart Products & Components

Sebastian Krause
Vice President Product Development

EU DECLARATION OF CONFORMITY

TRANSLATION



Declaration of Conformity of Final Machinery

in accordance with Annex II, section 1.A. of the Directive 2006/42/EC

For the following product:

Type 3214/XXX-X Electric Control Valve consisting of Type 3214 Valve and TROVIS 5724-X, TROVIS 5725-X, Type 5824, Type 5825, Type 5827, Type 3274 or Type 3374 Actuator

We hereby declare that the machinery mentioned above complies with all applicable requirements stipulated in Machinery Directive 2006/42/EC.

For product descriptions refer to:

- Type 3214/... Electric and Pneumatic Control Valves:
Mounting and Operating Instructions EB 5868/5869

Referenced technical standards and/or specifications:

- VCI, VDMA, VGB: "Leitfaden Maschinenrichtlinie (2006/42/EG) – Bedeutung für Armaturen, Mai 2018" [German only]
- VCI, VDMA, VGB: "Zusatzdokument zum Leitfaden Maschinenrichtlinie (2006/42/EG) – Bedeutung für Armaturen vom Mai 2018" [German only], based on DIN EN ISO 12100:2011-03

Comment:

Information on residual risks of the machinery can be found in the mounting and operating instructions of the valve and actuator as well as in the referenced documents listed in the mounting and operating instructions.

Persons authorized to compile the technical file:

SAMSON AG, Weismüllerstraße 3, 60314 Frankfurt am Main, Germany
Frankfurt am Main, 10 October 2023

A handwritten signature in blue ink, appearing to read "ppc. Norbert Tollas".

Norbert Tollas
Senior Vice President
Global Operations

A handwritten signature in blue ink, appearing to read "i. v. P. Scheermesser".

Peter Scheermesser
Director
Product Maintenance & Engineered Products

EU DECLARATION OF CONFORMITY TRANSLATION



Declaration of Conformity of Final Machinery

in accordance with Annex II, section 1.A. of the Directive 2006/42/EC

For the following product:

Type 3222/XXXX-X Electric Control Valve consisting of Type 3222 Valve and 5857, 5824, 5825, 5827, TROVIS 5757-X, TROVIS 5724-X or TROVIS 5725-X Actuator

We hereby declare that the machinery mentioned above complies with all applicable requirements stipulated in Machinery Directive 2006/42/EC.

For product descriptions refer to:

- Electric and Pneumatic Control Valves Type 3222/...:
Mounting and Operating Instructions EB 5866

Referenced technical standards and/or specifications:

- VCI, VDMA, VGB: "Leitfaden Maschinenrichtlinie (2006/42/EG) – Bedeutung für Armaturen, Mai 2018" [German only]
- VCI, VDMA, VGB: "Zusatzdokument zum Leitfaden Maschinenrichtlinie (2006/42/EG) – Bedeutung für Armaturen vom Mai 2018" [German only], based on DIN EN ISO 12100:2011-03

Comment:

Information on residual risks of the machinery can be found in the mounting and operating instructions of the valve and actuator as well as in the referenced documents listed in the mounting and operating instructions.

Persons authorized to compile the technical file:

SAMSON AG, Weismüllerstraße 3, 60314 Frankfurt am Main, Germany
Frankfurt am Main, 22 September 2023

A handwritten signature in blue ink, appearing to read "ppc. N. Tollas", written over a horizontal line.

Norbert Tollas
Senior Vice President
Global Operations

A handwritten signature in blue ink, appearing to read "i.v.P. [Signature]", written over a horizontal line.

Peter Scheermesser
Director
Product Maintenance and Engineered Products

EU DECLARATION OF CONFORMITY

TRANSLATION



Declaration of Conformity of Final Machinery

in accordance with Annex II, section 1.A. of the Directive 2006/42/EC

For the following product:

Electric Control Valve Type 3222 N/XXXX-X consisting of Type 3222 N Valve and Actuator Type 5857, TROVIS 5757-3 or TROVIS 5757-7

We hereby declare that the machinery mentioned above complies with all applicable requirements stipulated in Machinery Directive 2006/42/EC.

For product descriptions refer to:

- Electric Control Valves Type 3222 N/5857, Type 3222 N/5757-3 and Type 3222 N/5757-7: Mounting and Operating Instructions EB 5867

Referenced technical standards and/or specifications:

- VCI, VDMA, VGB: "Leitfaden Maschinenrichtlinie (2006/42/EG) – Bedeutung für Armaturen, Mai 2018" [German only]
- VCI, VDMA, VGB: "Zusatzdokument zum Leitfaden Maschinenrichtlinie (2006/42/EG) – Bedeutung für Armaturen vom Mai 2018" [German only], based on DIN EN ISO 12100:2011-03

Comment:

Information on residual risks of the machinery can be found in the mounting and operating instructions of the valve and actuator as well as in the referenced documents listed in the mounting and operating instructions.

Persons authorized to compile the technical file:

SAMSON AG, Weismüllerstraße 3, 60314 Frankfurt am Main, Germany
Frankfurt am Main, 22 September 2023

A handwritten signature in blue ink, appearing to read "ppc. N. Tollas".

Norbert Tollas
Senior Vice President
Global Operations

A handwritten signature in blue ink, appearing to read "i.v.P. Scheermesser".

Peter Scheermesser
Director
Product Maintenance & Engineered Products

Certificate

EU-Type examination – production type in accordance with Directive 2014/68/EU

Certificate no.: 01 202 641/B-19-0017-01

Name and address of the
manufacturer:

Samson AG
Weismüllerstraße 2
60314 Frankfurt am Main
Germany

It is herewith certified that the type specimen mentioned below
meets the requirements of the Directive 2014/68/EU.

Tested acc. to Directive
2014/68/EU:

Module B
EU-Type examination – production type

Test report no.:

968/FSP 1949.05/21

Description of type specimen:

Actuators for water and steam with safety function

Type:

Actuator type 5725, 5825, 5827 (2770) with final control
elements types 3214 (2814), 2423 (2823), 3213 (2710), 3222
(2710), 2488 (2730), 2489 (2730)

Manufacturing plant/Supplier:

Samson AG
Weismüllerstraße 2
60314 Frankfurt am Main
Germany

Valid until:

11/2029
This certificate becomes invalid if the product is changed or
modified in any way.

The CE marking must not be affixed and the Declaration of Conformity not be issued prior to
completion of the corresponding conformity assessment procedure according to Directive
2014/68/EU.

Cologne, 2021-11-24



TÜV Rheinland Industrie Service GmbH
Notified Body for Pressure Equipment, ID-No. 0035
Am Grauen Stein, D-51105 Köln, GERMANY

Dipl.-Ing. Vera Ruff



ЕВРАЗИЙСКИЙ ЭКОНОМИЧЕСКИЙ СОЮЗ ДЕКЛАРАЦИЯ О СООТВЕТСТВИИ

Заявитель Общество с ограниченной ответственностью "САМСОН КОНТРОЛС".

Основной государственный регистрационный номер: 1037700041026. Место нахождения и адрес места осуществления деятельности: 109544, город Москва, бульвар Энтузиастов, дом 2, этаж 5, комната 11, Российская Федерация. Телефон: +7 (495) 777-4545, адрес электронной почты: samson@samson.ru.

в лице Генерального директора Крымшамхалова Азрета Индрисовича, действующего на основании Устава.

заявляет, что Приводы электрические торговой марки SAMSON, типы: 5824, 5825, 5827.

Изготовитель "SAMSON AKTIENGESELLSCHAFT".

Место нахождения: Weismuellerstrasse 3, 60314 Frankfurt am Main, Федеративная Республика Германия. Адреса мест осуществления деятельности по изготовлению продукции: Weismuellerstrasse 3, 60314 Frankfurt am Main, ("SAMSON AKTIENGESELLSCHAFT"), Федеративная Республика Германия; ul. Spacerowa 30, 57-402 Nowa Ruda, ("Framo Morat Polska Sp. z o.o."), Польша.

Продукция изготавливается в соответствии со стандартами согласно приложению № 1.

Код ТН ВЭД ЕАЭС: 8501 10 930 0.

Серийный выпуск.

соответствует требованиям Технических регламентов Таможенного союза: "О безопасности низковольтного оборудования" (ТР ТС 004/2011), "Электромагнитная совместимость технических средств" (ТР ТС 020/2011).

Декларация о соответствии принята на основании эксплуатационной документации (руководства по эксплуатации 3428-ЭП-2021.РЭ, паспорта 3428-5824-30-2021.ПС); протокола № 1-06-2021 от 02.06.2021, выданного Испытательной лабораторией Общества с ограниченной ответственностью "НТЦ "ВОРОНЕЖ-ЭКСПЕРТ".

Схема декларирования соответствия: 1д.

Дополнительная информация ГОСТ 12.2.007.0-75 "Система стандартов безопасности труда. Изделия электротехнические. Общие требования безопасности"; ГОСТ 12.2.007.1-75 "Система стандартов безопасности труда. Машины электрические вращающиеся. Требования безопасности"; ГОСТ 30804.6.2-2013 раздел 8 " Совместимость технических средств электромагнитная. Устойчивость к электромагнитным помехам технических средств, применяемых в промышленных зонах. Требования и методы испытаний"; ГОСТ 30804.6.4-2013 раздел 7 " Совместимость технических средств электромагнитная. Электромагнитные помехи от технических средств, применяемых в промышленных зонах. Нормы и методы испытаний".

Условия хранения: в отапливаемых хранилищах при температуре окружающего воздуха от минус 20 °С до плюс 70 °С и относительной влажности до 70%. Назначенный срок хранения: 24 месяца. Назначенный срок службы: 12 лет.

Декларация о соответствии действительна с даты регистрации по 15.06.2026 включительно.

(подпись)



Крымшамхалов Азрет Индрисович
(Ф.И.О. заявителя)

Регистрационный номер декларации о соответствии:

ЕАЭС N RU Д-ДЕ.РА01.В.334/3/21

Дата регистрации декларации о соответствии: 16.06.2021

ЕВРАЗИЙСКИЙ ЭКОНОМИЧЕСКИЙ СОЮЗ

ПРИЛОЖЕНИЕ № 1 К ДЕКЛАРАЦИИ О СООТВЕТСТВИИ ЕАЭС N RU Д-ДЕ.РА01.В.33473/21

Лист № 1 из 1

Наименования и реквизиты документов, в соответствии с которыми изготавливается продукция

| | |
|---|--|
| IEC 60730-1:2013 / Cor. 1:2014 "Automatic electrical controls for household and similar use. Part 1. General requirements. Corrigendum 1" | "Устройства управления автоматические электрические. Часть 1. Общие требования. Поправка 1" |
| EN 61000-6-1:2007 "Electromagnetic compatibility (EMC) - Part 6-1: Generic standards - Immunity for residential, commercial and light-industrial environments" | "Электромагнитная совместимость. Часть 6-1. Общие стандарты. Помехоустойчивость для жилых районов, районов с коммерческими предприятиями и районов с небольшими производственными предприятиями" |
| IEC 61000-6-2:2016 "Electromagnetic compatibility (EMC). Part 6-2: Generic standards. Immunity for industrial environments" | "Электромагнитная совместимость (ЭМС). Часть 6-2: Общие стандарты. Помехоустойчивость для промышленных сред" |
| EN 61000-6-3:2007 + A1:2011 "Electromagnetic compatibility (EMC). Part 6-3: Generic standards. Emission standard for residential, commercial and light-industrial environments" | "Электромагнитная совместимость (ЭМС). Часть 6-3: Общие стандарты. Стандарт излучения для жилых, коммерческих и легких промышленных сред" |
| IEC 61010-1:2010 "Safety requirements for electrical equipment for measurement, control, and laboratory use. Part 1: General requirements" | "Требования безопасности к электрическому оборудованию для измерения, контроля и лабораторного использования. Часть 1: Общие требования" |
| EN 61326-1:2013 "Electrical equipment for measurement, control and laboratory use. EMC requirements. Part 1: General requirements" | "Электрооборудование для измерения, контроля и лабораторного использования. Требования ЭМС. Часть 1: Общие требования" |



(подпись)

Крымшамхалов Азрет Индрисович

(Ф.И.О. заявителя)



Declaration of Incorporation in Compliance with Machinery Directive 2006/42/EC

For the following product:

Type 5827 Actuator

We certify that the Types 5824 and 5825 Electric Actuators are partly completed machinery as defined in the Machinery Directive 2006/42/EC and that the safety requirements stipulated in Annex I, 1.1.2, 1.1.3, 1.1.5, 1.2.1, 1.2.2, 1.2.3, 1.2.5, 1.2.6, 1.3.1, 1.3.2, 1.3.3, 1.3.4, 1.3.7, 1.3.8.2, 1.3.9, 1.4.1, 1.5.1, 1.5.3, 1.5.4 and 1.5.8 are observed. The relevant technical documentation described in Annex VII, part B has been compiled.

Products we supply must not be put into service until the final machinery into which it is to be incorporated has been declared in conformity with the provisions of the Machinery Directive 2006/42/EC.

Operators are obliged to install the products observing the accepted industry codes and practices (good engineering practice) as well as the mounting and operating instructions. Operators must take appropriate precautions to prevent hazards that could be caused by the process medium and operating pressure in the valve as well as by the signal pressure and moving parts.

The permissible limits of application and mounting instructions for the products are specified in the associated mounting and operating instructions; the documents are available in electronic form on the Internet at www.samsongroup.com.

For product descriptions refer to:

- Type 5827 Electric Actuator: Mounting and Operating Instructions EB 5827-1 / EB 5827-2

Referenced technical standards and/or specifications:

- VCI, VDMA, VGB: "Leitfaden Maschinenrichtlinie (2006/42/EG) – Bedeutung für Armaturen, Mai 2018" [German only]
- VCI, VDMA, VGB: "Zusatzdokument zum Leitfaden Maschinenrichtlinie (2006/42/EG) – Bedeutung für Armaturen vom Mai 2018" [German only], based on DIN EN ISO 12100:2011-03

Comments:

- See mounting and operating instructions for residual hazards.
- Also observe the referenced documents listed in the mounting and operating instructions.

Persons authorized to compile the technical file:

SAMSON AG, Weismüllerstraße 3, 60314 Frankfurt am Main, Germany
Frankfurt am Main, 21 February 2021

A handwritten signature in blue ink, appearing to read "i.v. Giesen".

Stephan Giesen
Director
Product Management

A handwritten signature in blue ink, appearing to read "i.v. S. Krause".

Sebastian Krause
Director
Strategic R&D, Valves and Actuators

16 Appendix A

i Note

The actuator is configured with the TROVIS-VIEW software (► EB 6661).

16.1 Location of LEDs and switches

i Note

The location of the operating direction switch, function switch and LEDs of the latest 24 V version of this electric actuator are shown in Chapters 6 and 7. The images and descriptions that apply to previous versions of the actuator are included in this chapter.

NOTICE

Specified degree of protection does not apply when the housing cover is open.

⇒ Ensure that no moisture or foreign particles can get into the actuator.

16.1.1 LEDs

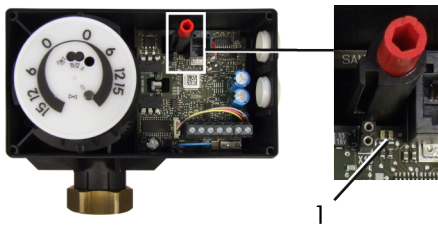

Fig. 31: Location of LEDs (24 V version)

1 Red and yellow LEDs

16.1.2 Function switch

Switch position A (default):

- Input signal 0 to 10 V or 0 to 20 mA
- Input signal settings in TROVIS-VIEW **override the switch positions.**

Switch position B:

- Input signal 2 to 10 V or 4 to 20 mA
- Input signal settings in TROVIS-VIEW **are ignored.**

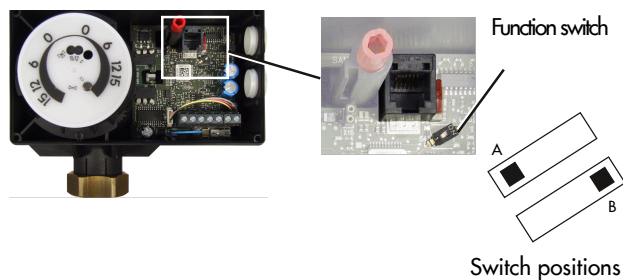

Fig. 32: Function switch (24 V version)

16.1.3 Operating direction switch

Switch position A (default):

Direction of action increasing/increasing (>>)

- The actuator stem retracts as the input signal increases.

Switch position B:

Direction of action increasing/decreasing (<>)

- The actuator stem extends as the input signal increases.

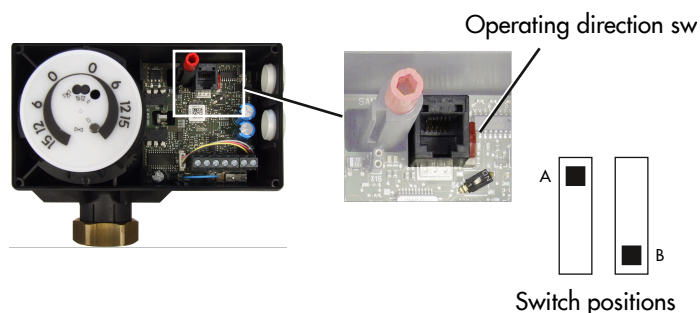

Fig. 33: Operating direction switch (24 V version)

16.2 Input signal

The input signal determines the actuator stem position. A voltage or current signal can be used as the input signal. The default lower and upper range values of the input signal are 0 to 10 V or 0 to 20 mA.

i Note

At least 2.5 V or 5 mA (depending on the input signal used) must separate the upper and lower range values.

⇒ Select 'Settings' folder (> 'Inputs and outputs'). The settings for the input and output signal are shown.

Settings > Inputs and outputs> Input signal

| Input signal | Default | Adjustment range |
|-------------------|-----------------|---------------------------------|
| Lower range value | 0.0 V or 0.0 mA | 0.0 to 7.5 V or 0.0 to 15 mA |
| Upper range value | 10 V or 20 mA | 2.5 to 10.0 V or 5.0 to 20.0 mA |

16.2.1 Split-range operation

The input signal range can be adapted, e.g. to achieve a plant operation characteristic by connecting two or more actuators in parallel (split-range operation).

Example:

Two valves regulate the process medium in one common pipeline to achieve a large rangeability. One valve opens with a 0 to 5 V input signal, while the second valve also opens when the input signal increases further (5 to 10 V) and the first valve remains open. The two valves close in the reverse order.

16.3 Position feedback signal

The position feedback indicates the position of the actuator stem. The span of the position feedback signal is adjusted over the lower and upper range value parameters.

Settings > Inputs and outputs > Position feedback signal

| Position feedback signal | Default | Adjustment range |
|--|---------|------------------|
| Lower range value | 0.0 V | 0.0 to 10.0 V |
| Upper range value | 10.0 V | 0.0 to 10.0 V |
| Indicate error at relative stem position | Yes | Yes/No |

16.4 Functions

16.4.1 Detect input signal failure

The positioner detects a failure of the input signal as soon as the value falls below the lower range value by 0.3 V or 0.6 mA. An input signal failure is indicated in the 'Service' folder (> 'Operating states') as well as by the red LED.

Input signal failure detected

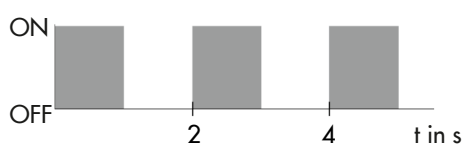

i Note

The 0 to 10 V or 0 to 20 mA setting for the input signal is not possible in combination with this function. The lower value must be at least 0.5 V or 1 mA to ensure a signal failure can be detected.

If the **Detect input signal failure** function is active, the reaction of the actuator upon failure of the input signal is determined by the 'Positioning value upon input signal failure' parameter.

- 'Positioning value upon input signal failure' = **Internal positioning value**
The actuator stem moves to the position specified in the 'Internal positioning value' parameter upon failure of the input signal.
- 'Positioning value upon input signal failure' = **Last travel value**
The actuator stem remains in the last position that the valve moved to before failure of the input signal.

The error message is reset and the actuator returns to closed-loop operation if the input signal moves within 0.2 V or 0.4 mA of the lower range value.

Settings > Actuator > Functions

| Function | Default | Adjustment range |
|---|----------------------------|--|
| Detect input signal failure | No | Yes/No |
| Positioning value upon input signal failure | Internal positioning value | Internal positioning value/last travel value |
| Internal positioning value | 0.0 % | 0.0 to 100 % |

16.4.2 End position guiding

The actuator stem moves to the end position earlier if the end position guiding function is active.

- 'Value below limit (end position guiding)'
The actuator stem moves to the 0 % position when the input signal reaches the entered value.
- 'Value above limit (end position guiding)'
The actuator stem moves to the 100 % position when the input signal reaches the entered value.

Settings > Actuator > Functions

| Function | Default | Adjustment range |
|--|---------|------------------|
| Value below limit (end position guiding) | 1.0 % | 0.0 to 49.9 % |
| Value above limit (end position guiding) | 97.0 % | 50.0 to 100.0 % |

i Note

When 'Value below limit (end position guiding)' = 0 % and 'Value above limit (end position guiding)' = 100 %, the end position guiding function is deactivated.

16.5 Blockage

16.5.1 Blocking protection

The blocking protection prevents the valve from seizing up. If the actuator stem is in the 0 % position, it is extended slightly and then retracted 24 hours after it last moved. Movement of the actuator stem caused by the activated blocking protection is indicated by the yellow LED.

Blocking protection in progress

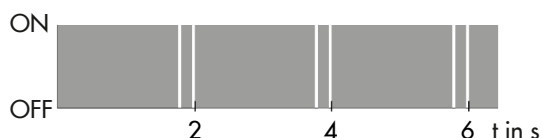

Settings > Actuator > Blockage

| Function | Default | Adjustment range |
|---------------------|---------|------------------|
| Blocking protection | No | Yes/No |

16.6 Travel

16.6.1 Limited travel range

The **Limited travel range** parameter determines in % how far the actuator stem can move at the maximum. The travel determined during initialization acts as the reference.

Settings > Actuator > Travel

| Function | Default | Adjustment range |
|----------------------|---------|------------------|
| Limited travel range | 100 % | 30.0 to 100.0 % |

16.6.2 Travel adjustment

Travel adjustment can be made to be absolute or relative. The way the travel adjustment is made affects the control behavior.

Absolute travel adjustment

- The absolute travel adjustment causes the actuator stem to move to the travel position determined by the input signal. To achieve this, an automatic zero calibration is performed after every start-up to obtain a reference value for the zero point. The position feedback indicates the position of the actuator stem.

Relative travel adjustment

- The relative travel adjustment causes the change in input signal to be reproduced by the position of the actuator stem. The actuator stem extends or retracts from the current actuator stem position corresponding to the change in signal. After starting up the actuator, a zero calibration is not performed. The stem position is unknown on reconnection after power failure. The input signal is assigned as the start value. 12 V is issued as the position feedback signal. The stem position is recognized again when the actuator stem reaches the end position 'Actuator stem extended' and, at the same time, the input signal is 0 %.

Settings > Actuator > Travel

| Function | Default | Adjustment range |
|-------------------|----------|-------------------|
| Travel adjustment | Absolute | Absolute/Relative |

Tip

In closed-loop operation, the positioner must be operated with absolute travel adjustment (default setting).

16.6.3 Idle time during end position guiding

The idle time for **relative travel adjustment** paces the gradual movement of the actuator stem towards the end position. With the relative stem position, the input signal can preset a value of 0 % or 100 %. However, the actuator stem can only be moved to its upper range value. The input signal cannot move the actuator stem beyond this position. The actuator stem is moved towards the end position in steps with the hysteresis. The idle time defines the time between the steps. The paced stem movement is deactivated when the value is set to 0.

Settings > Actuator > Functions

| Function | Default | Adjustment range |
|---------------------------------------|---------|------------------|
| Idle time during end position guiding | 0 s | 0 to 99 s |

Note

The further description refers to the operation with absolute travel adjustment, unless specified otherwise.

16.6.4 Speed

The actuator stem moves to the position determined by the input signal at the selected stroking speed. There are three speed levels.

- Slow = 0.135 mm/s
- Normal = 0.197 mm/s
- Fast = 0.365 mm/s

Settings > Actuator > Travel

| Function | Default | Adjustment range |
|----------|---------|------------------|
| Speed | Normal | Slow/Normal/Fast |

i Note

The transit time is calculated from the travel and the stroking speed. The transit time is the time that the actuator stem needs to move through the adjusted travel.

The following applies:

$$\text{Transit time in s} = \frac{\text{Travel in mm}}{\text{Stroking speed in mm/s}}$$

16.6.5 Dead band (switching range)

Dead band (switching range)

The dead band suppresses slight movements of the stem. The dead band represents the sum of the positive and negative hysteresis. After the actuator has been stationary, the input signal must change by at least half of the dead band to cause the actuator stem to move again.

Settings > Actuator > Travel

| Function | Default | Adjustment range |
|-----------------------------|---------|------------------|
| Dead band (switching range) | 2.0 % | 0.5 to 5.0 % |

16.6.6 Characteristic

The characteristic expresses the relation between the input signal and the actuator stem position (direction of action increasing/increasing >>).

Perform the characteristic settings in the 'Settings' folder (> Actuator > Characteristic).

Settings > Actuator > Characteristic

| Function | Default | Adjustment range |
|---------------------|---------|--|
| Characteristic type | Linear | Linear Equal percentage Reverse equal percentage User-defined |

Appendix A

- **Linear:**

The travel is proportional to the input signal.

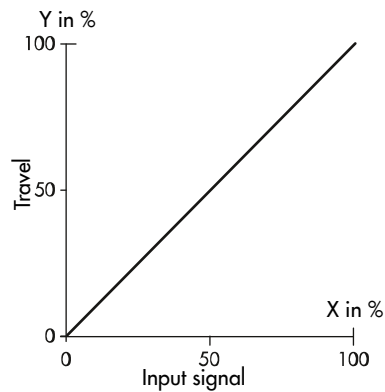

- **Equal percentage:**

The travel is exponential to the input signal.

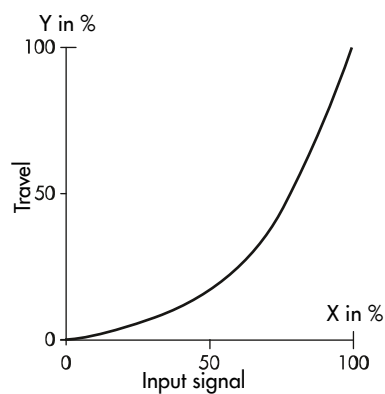

- **Reverse equal percentage:**

The travel is reverse exponential to the input signal.

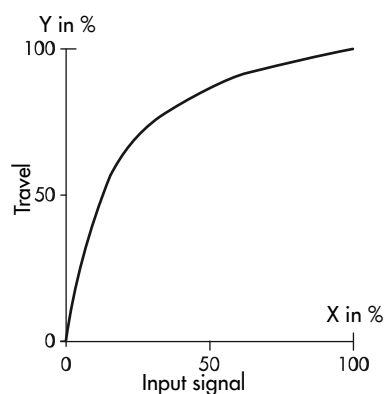

- **User-defined:**

A new characteristic based on the last characteristic used can be defined over eleven points.

16.6.7 Start-up

Initialization can be started in the 'Service' folder (> 'Start-up').

16.6.8 Functions ('Service')

The functions described below can be performed in the 'Service' folder (> 'Functions').

16.6.8.1 Manual level

The actuator can be switched to the manual mode if the manual level is enabled in online mode in TROVIS-VIEW. The actuator leaves the manual mode as soon as you exit the manual level or online mode in TROVIS-VIEW. The following actions can be activated in the manual level:

- Retract actuator stem
- Extend actuator stem
- Move actuator stem to standardized value

- ⇒ First enter the required positioning value in relation to the input signal range (standardized positioning value).
- Issue standardized position feedback
- ⇒ First enter the required position feedback in relation to the span of the position feedback signal (standardized position feedback).
- Issue error message
- Activate the yellow LED
- Activate the red LED

16.6.8.2 Functions

Perform reset

The actuator is restarted.

Load default settings in actuator

The configuration is reset to the default setting.

Start zero calibration





The actuator moves to the lower end position (stem extended). After the zero calibration is completed, the transit time is adopted and the actuator is ready for operation. The actuator stem is moved to the position determined by the input signal.

Start transit time measurement

Measures the time required to move from one end position to the other.

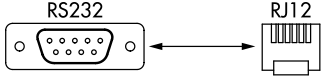
17 Appendix B

17.1 Accessories

| Accessories | Order no. |
|--|---|
| Hardware package consisting of: - Memory pen-64 - Connecting cable RJ-12/D-sub, 9 pin - Modular adapter | 1400-9998 |
| Connecting cable RJ-12/D-sub, 9 pin | 1400-7699  |
| Memory pen-64 | 1400-9753  |
| Modular adapter | 1400-7698  |
| USB to RS-232 adapter | 8812-2001  |
| Software | |
| TROVIS-VIEW (free of charge) | ▶ www.samsongroup.com > DOWNLOADS > Software & Drivers > TROVIS-VIEW |
| Cable glands | |
| M16x1.5 cable gland for 4 to 8 mm clamping range | 100243686 |
| M16x1.5 cable gland for 5 to 10 mm clamping range | 1402-9857 |
| For mounting on form-fit valves without return spring ¹⁾ | |
| Yoke for Series V2001 Valves | 1400-7414 |
| Spacer to mount the actuator on Type 3323 Valve (DN 65 to 80) | 0340-3031 |

¹⁾ With Type 5827-x3x Electric Actuator

17.2 After-sales service

Contact our after-sales service for support concerning service or repair work or when malfunctions or defects arise.

You can reach our after-sales service at the following e-mail address.

▶ aftersaleservice@samsongroup.com

The addresses of SAMSON AG, its subsidiaries, representatives and service facilities worldwide can be found on our website (▶ www.samsongroup.com) or in all product catalogs.

Please submit the following details:

- Type designation
- Material number
- Serial number
- Firmware version

17.3 Configuration list and customer-specific data

| Configuration | Default setting | Adjustment range | Setting |
|---|----------------------------|---|---------|
| Input signal | | | |
| Lower range value | 0.0 V 0.0 mA | 0.0 to 7.5 V 0.0 to 15.0 mA | |
| Upper range value | 10.0 V 20.0 mA | 2.5 to 10.0 V 5.0 to 20.0 mA | |
| Unit | V | V/mA | |
| Position feedback signal | | | |
| Lower range value | 0.0 V | 0.0 to 10.0 V | |
| Upper range value | 10.0 V | 0.0 to 10.0 V | |
| Functions | | | |
| Detect input signal failure | No | Yes/No | |
| Positioning value upon input signal failure | Internal positioning value | Internal positioning value/last travel value | |
| Internal positioning value | 0.0 % | 0.0 to 100 % | |
| Value below limit (end position guiding) | 1.0 % | 0.0 to 49.9 % | |
| Value above limit (end position guiding) | 97.0 % | 50.0 to 100.0 % | |
| Blockage | | | |
| Blocking protection | No | Yes/No | |
| Travel | | | |
| Limited travel range | 100.0 % | 30.0 to 100 % | |
| Travel adjustment | Absolute | Absolute/Relative | |
| Speed | Normal | Slow/Normal/Fast | |
| Dead band (switching range) | 2.0 % | 0.5 to 5.0 % | |
| Characteristic type | Linear | Linear/Equal percentage/Reverse equal percentage/User-defined | |



SAMSON AKTIENGESELLSCHAFT
Weismüllerstraße 3 · 60314 Frankfurt am Main, Germany
Phone: +49 69 4009-0 · Fax: +49 69 4009-1507
samson@samsongroup.com · www.samsongroup.com