



 **Introduction**

These installation instructions contain important information on the installation, functioning, maintenance and storage of VETEC valves. The control valves are supplied according to customer specification, complete with actuator and accessories. The valves comply with the European Pressure Equipment Directive 2014/68/EU.

 **General safety instructions**

The control valves are to be mounted, started up or serviced by fully trained and qualified personnel only; the accepted industry codes and practices are to be observed. Make sure employees or third persons are not exposed to any danger.

The safety regulations relevant to the plant (e.g. explosion protection, ATEX, corrosive/dangerous media etc.) as well as the accepted industry codes and practices are to be observed during installation, operation and maintenance.

The manufacturer does not assume any responsibility for damage caused by external forces or any other external influence.

Any hazards that could be caused by the operating and ambient conditions or by moving parts are to be prevented by means of the appropriate measures.

External fires are to be prevented by means of the appropriate measures by the operator.

Valves with hot, touchable surfaces are to be protected according to DIN EN 563 to prevent burn injuries.

Proper shipping and storage of the control valves in accordance with the relevant regulations are assumed.

For weights refer to the delivery notes.

When using manual gears (handwheels) on the actuator, observe the operating instructions to prevent the valve and actuator from being damaged.

 **Intended use**

VETEC control valves are sized individually according to the specific operating conditions provided by the customer, such as process medium, operating pressure and operating temperature.

The limits of application for DVGW valves concerning the process medium, operating pressure, operating temperature and supply pressure are given on the nameplate.

Make sure the valves are used as intended.

If the valves are to be used under deviating operating conditions, contact VETEC Ventiltechnik GmbH to make sure that the valves are suitable for the requirements. Failure to check the valves' suitability for deviating conditions can lead to malfunctions and pose a considerable danger to persons, goods and the environment.



Assembly and disassembly

Install the control valves into the pipeline and connect them to the lines for the air supply and control signal observing the accepted industry codes and practices.

For installing the valve into the pipeline we recommend a minimal distance of “a” nominal valve size (a x DN) in front of the valve and “b” nominal valve size (b x DN) behind the valve.

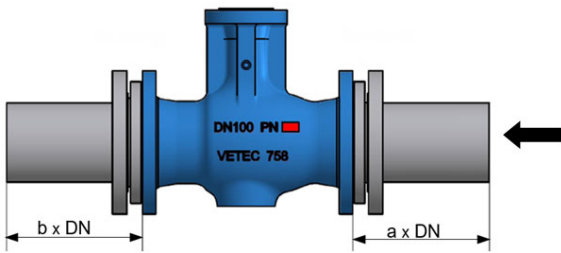

Medium	Ventilbedingungen	a	b
Gas	$Ma \leq 0,3$	2	4
	$0,3 < Ma \leq 0,7$	2	10
Vapors	$Ma \leq 0,3$ / No saturated steam	2	4
	$0,3 < Ma \leq 0,7$ / No saturated steam	2	10
	Saturated steam (percentage of condensate > 5 %)	2	20
Liquid	Free of cavitatio / $w < 10$ m/s	2	4
	Cavitation producing noise / $w < 3$ m/s	2	4
	Cavitation producing noise / $3 < w < 5$ m/s	2	10
	Critical cavitation / $w \leq 3$ m/s	2	10
Flashing	-	2	20
	-	10	20
Multi-phase	-	10	20

For operating conditions not listed in the table and for solids, contact VETEC After Sales.

An insufficient cross-section of the supply air line or an insufficient supply pressure impair the valves' control response or proper functioning. An excessive supply pressure can damage the actuator and accessories.

Shut off, drain and vent the respective pipe section according to the operator's instructions before installing or removing the valves. Pressure-test the pipeline before installing the valves.

Make sure the pipeline is free of any residue (e.g. weld spatter, metal chips, tools etc.). Remove any foreign particles. Make sure the valves are mounted free of stress and not exposed to excessive vibration.

If the actuators require support in the pipeline, observe the permissible locations. The permissible locations and weights for support are detailed in the VETEC regulations. Do not use the piping and control equipment as support or to suspend valves during transport; do not step on the piping and control equipment to prevent damage.

Subject all valves taken from stock to safety, functional and leak tests before use.

Failure to follow the instructions properly can lead to malfunctions and pose a considerable danger to persons, goods and the environment.



Operation

The control valves, as parts of the plant, are to be operated according to the operator's instructions and regulations. Unstable control causes increased wear. Contaminated supply air (e.g. with oil, water, dirt) or auxiliary energy and signals not according to specifications can cause the accessories or the entire control valve to malfunction or fail. Protect the valves against impermissible internal or external stress during operation.

The operator must make sure that the valves' permissible pressure and temperature limits are not exceeded due to a thermal expansion of the process medium.

Wear and corrosion may make it necessary to check the wall thickness of the valve bodies at regular intervals. The minimum required wall thickness is calculated and specified by VETEC.

The valves must be checked for their function at regular intervals (1 x monthly). Perform at least one complete switching cycle.



Service and maintenance

The valves do not require maintenance. However, they are subject to natural wear, whose extent depends on the operating conditions. Wear can be identified by an impaired shut-off, increased external leakage, deteriorating control quality or unusual noise emissions.

When repairing or replacing parts subject to wear on disassembled valves in the workshop, proceed as described in the mounting and operating instructions. Only use original spare parts by VETEC Ventiltechnik GmbH.

As the valves may contain residue of the process medium, we recommend to remove the valves from the pipeline observing the medium-specific safety instructions.

Depending on the field of application, allow the valves to cool down or heat up to reach ambient temperature before starting any work on them.

Before starting any work on the valves or actuators, shut off the pneumatic and electric supplies to prevent any hazards

caused by moving parts of the valves or actuators. In particular, make sure that the actuator springs remain compressed even after the actuators have been vented and the supply has been shut off. This is particularly important to remember when removing the actuators from the valves or when opening the actuators.

When changing or retrofitting packing systems, e.g. according to TA-Luft, observe the VETEC mounting instructions.

When mounting pressure-bearing parts on the valves, observe the tightening torques for bolts and screw connections specified in the maintenance instructions.

Marking

The valves have a tag (identification plate). The tag is attached to the actuator or, for deliveries without actuator, to the valve's connecting flange.

Conformity with the European Pressure Equipment Directive 2014/68/EU is documented by the CE marking on the tags. Exception: valves according to 2014/68/EU, Article 4, Paragraph 3 (good engineering practice).

The valve and actuator types, nominal size, nominal pressure, serial number, order number etc. are specified on the tags (identification plate).

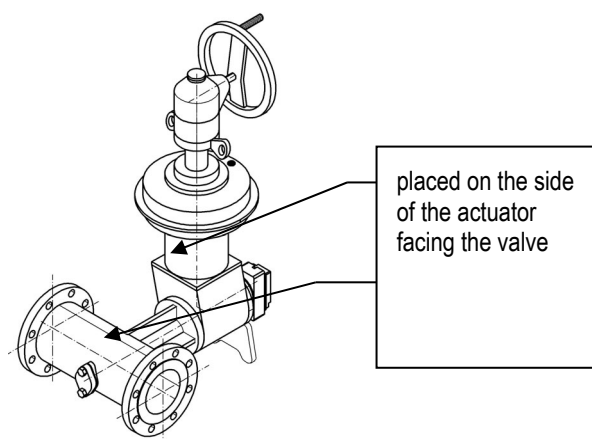
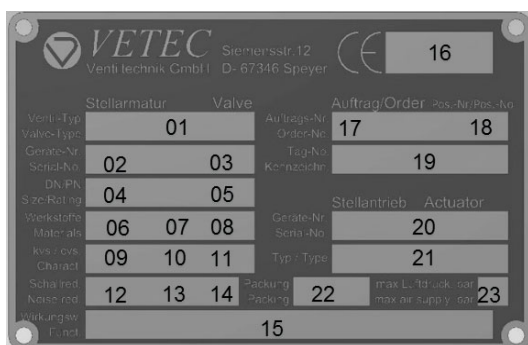

Description of the tag (identification plate)

- | | |
|--|---|
| 1 Ventil Typ / valve type | 12 Schallmaßnahme, falls vorhanden / noise reduction if applicable |
| 2 Ventil Serien-Nr. / valve serial no. | 13 Entfällt / n.a. |
| 3 Baujahr/year of manufacture | 14 Entfällt / n.a. |
| 4 Nennweite / nominal size | 15 Sicherheitsstellung bei Hilfsenergie Ausfall / fail safe position without power supply |
| 5 Nenndruck / nominal pressure | 16 CE-Kennzeichen / CE mark |
| 6 Gehäusewerkstoff / body material | 17 VETEC Auftragsnummer / VETEC order no. |
| 7 Werkstoff Sitz / seat material | 18 Auftragspositionsnummer / order pos. no. |
| 8 Werkstoff Sitz-Dichtkante / seat facing material | 19 MSR Nr. / Tag No. |
| 9 Kvs-Wert / kvs value | 20 Seriennr. Antrieb / serial no. actuator |
| 10 Cvs-Wert / cvs value | 21 Antriebstyp / actuator type |
| 11 Armaturen-Kennlinie / valve flow characteristic | 22 Packungsausführung / packing |
| | 23 Max. zul. Zuluftdruck des Stellantriebes/ max. air supply |

The serial number is stamped onto the flange for future inquiries and spare part orders.

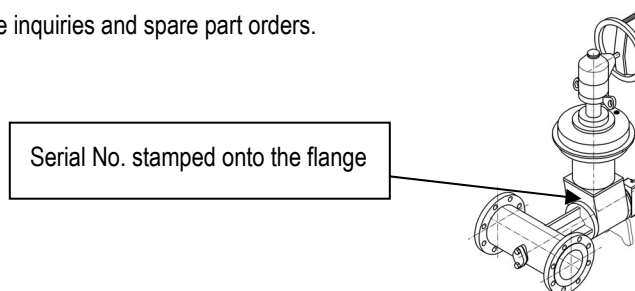

! Installation into the pipeline

Mount the valve into the pipeline with the arrow on the body pointing in flow direction. Make sure the valve inlet is equipped with a filter or strainer if the absolute cleanness of the process medium is not ensured otherwise (e.g. central filtering unit)

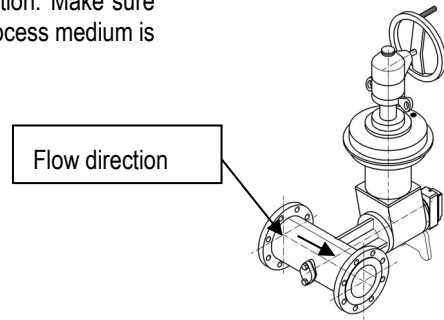

! Mounting position of the actuator

The actuator must be installed in the specified positions. Other mounting positions must be approved by VETEC before installation.

Mounting type B

FTC (spring closes, air opens)

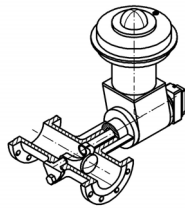

FTO (spring opens, air closes)

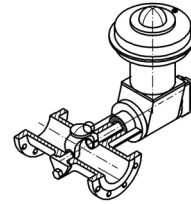

! Support

All Types MZ and MD Actuators listed in Table 01 are to be supported when mounted into the pipeline. Permissible locations for support are marked in the drawings. All actuator weights are given **without** manual gear (see Table 01). For actuator weights **with** manual gear refer to Table 02. For detailed information, observe the installation instructions **EB005.032**.

Table 01

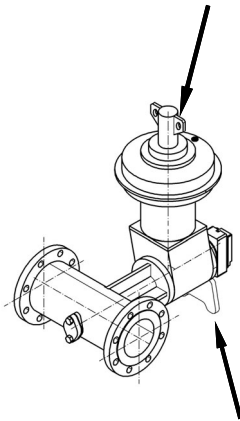
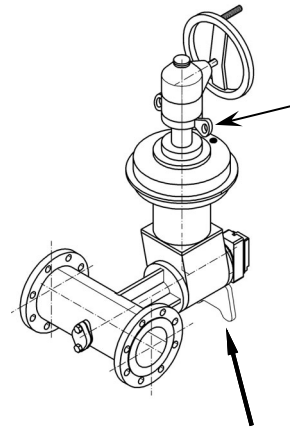

Table 02



Actuator	Weight
Type	Without manual gear
	in kg
MZ450/...	170
MZ700/...	600
MD450/...	370
MD700/...	700

Actuator	Weight
Type + handwheel	With manual gear
	in kg
MZ450/...+ GK14.6	200
MZ700/...+ GK25.2	710
MD450/...+ GK25.2	480
MD700/...+GK30.2	886

Transport for mounting

Use only the predefined locations to suspend the control valves during transport. When damaged, it can no longer be guaranteed that the valve moves to its fail-safe position (transit time). Use only the predefined locations to suspend the control valves during transport. Control lines, accessories as well as other components with fail-safe function must not be used as suspensions for transport. For detailed information, observe the handling and transport instructions **EB005.036**.

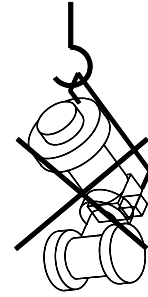

Without manual gear

All actuator weights are given **without** manual gear (see Table 01).

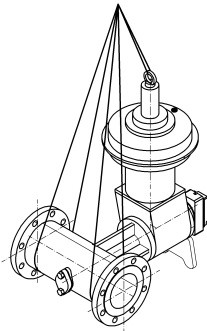

With manual gear

For actuator weights **with** manual gear refer to Table 02.

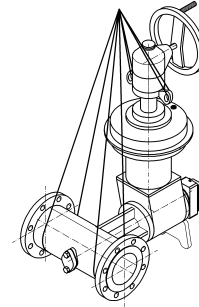

Accessories and control line

As DVGW valves are safety valves, all control lines, accessories and components for fail-safe function must be protected against improper use. When damaged, it can no longer be guaranteed that the valve moves to its fail-safe position (transit time). Any structural changes to the DVGW valves delivered by VETEC must be performed by trained personnel.

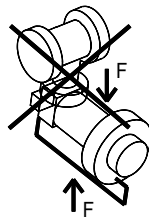

Make sure no improper forces act on the control line or accessories. Do not store the valve on the control line since this can cause damage.

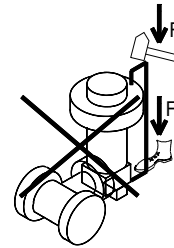

Do not step on the control line or accessories and do not damage them with tools.

! Insulating the pipeline and control valve

Insulate the valve so that neither the fail-safe action nor the proper functioning are impaired.

! Insulating valves with TA-Luft packing

Make sure no excessive temperatures or heat accumulation occur at the packing or seal. The recommended values given in the table are to be observed. Valves with TA-Luft packing are marked specially.

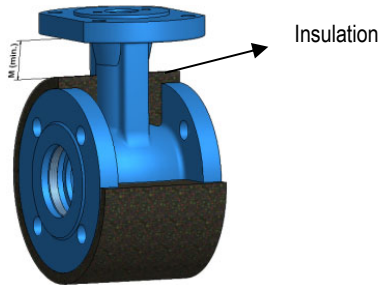
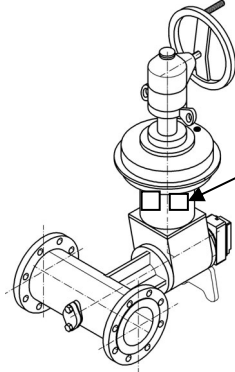

Valve size	Distance M in mm
25	50
40	60
50	60
80	60
100	60
150	100
200	100

! Starting up valves with longer heating-up time

For valves in sizes DN 200 or larger and for operating temperatures above 200 °C, expansion of the components due to heat cannot be avoided. Since the components are made of different materials, the degree and direction of heat-induced expansion, due to the design, are not exactly defined.

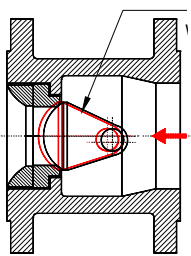

During the heating-up period, the heat is distributed rather unevenly across the valve. The components expand differently. As a result, the plug can get jammed in the seat ring (see drawing).

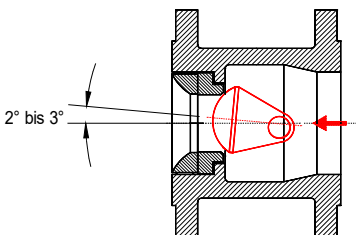

As a result, open the valve slightly (angle of approx. 2° to 3°) before start-up and close it again after start-up when the process medium has distributed the heat evenly (see drawing).

The valve can be opened by the specified angle using the actuator or additionally mounted travel stops on the actuator.

⚠ Electrostatic discharge

Electrostatic charging may occur on the valve bodies during operation in the plant, particularly on valves with insulation. As a result, include a ground connection as a safety measure.

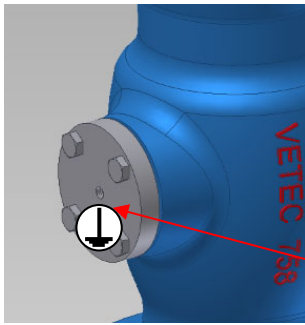

Ground connection
Safety measure against electrostatic charging

⚠ Caution!
The threaded area must be free of paint.

⚠ Valves with ceramic trims

Valves with ceramic trims bear a special label.

**!!! Caution !!!
Ceramic**

Do not subject ceramic parts to sudden temperature increases or other thermal shocks. Strictly observe the thermal shock limits.

Valves with retaining ring (Types 72.2, 72.6, 72.2P) must be open when installing them into the pipeline

Do not expose valves with ceramic trims and ceramic spare parts to sudden mechanical stress.

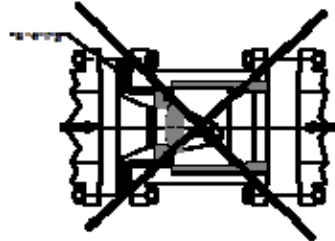
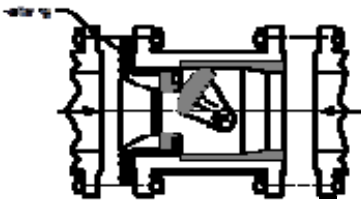

To ensure tight shut-off towards the atmosphere, cover the area between the armored bushing and the body with a sealing surface on both sides.

DN Valve size	A	B Inside pipe dimensions acc. to Series 01
mm	mm	mm
25	64	28.5
40	82	43.1
50	100	54.5
80	132	82.5
100	162	107.1
150	217	159.3
200	272	206.5
250	326	258.8
300	377	307.9

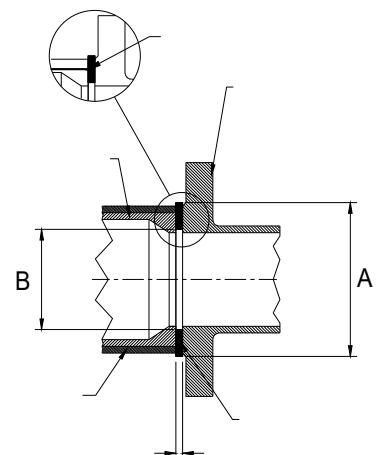

! Assembling actuators and accessories

The mounting of actuators and accessories must not take place by hard strokes.

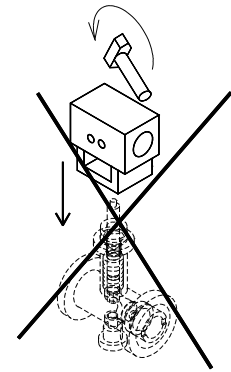

! Cleaning and rinsing pipelines before start-up

While the pipeline is being rinsed, any residue from mounting (welding spatter, etc.) or from tools (wrench sockets, nuts, etc.) can damage the valve.

Particularly, valves with soft-seated plugs, strainer inserts, filter inserts, noise-reducing trims, perforated plates must be removed from the pipeline and replaced by adapters before rinsing the pipeline.

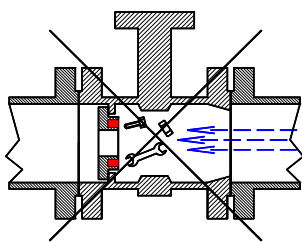

Valve with soft seat or plastic seat

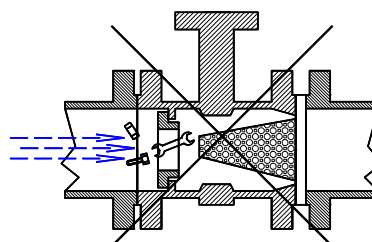

Noise-reducing trim

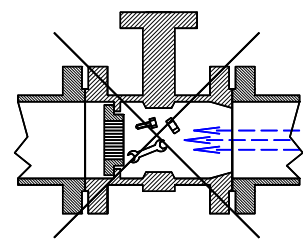

Seat ring with perforated plate

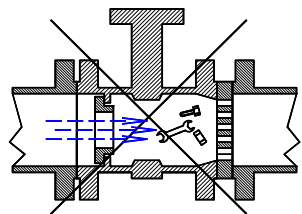

Perforated plate

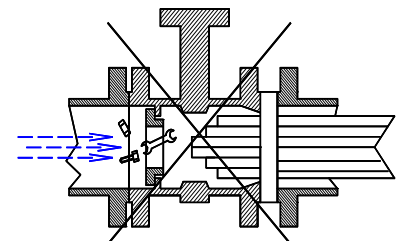

Flow divider

! Disassembling actuators, gears, bonnets, packing, nuts and bolts, stoppers or other pressure-bearing seal elements

! CAUTION! Do not remove the actuator from the valve while the valve is in operation in the pipeline/plant!

! CAUTION! Do not undo or remove external pressure-bearing components while the valve is in operation in the pipeline/plant!

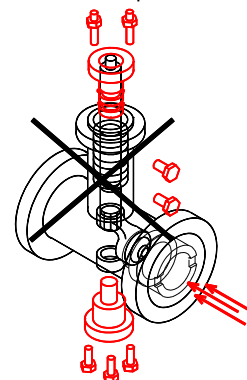
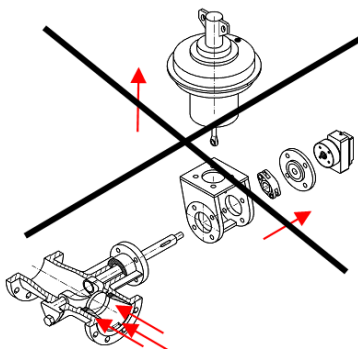



The lateral screw is not a port sniffer. It serves as a blow out for the shaft and therefore must not be removed during the operation in the pipeline or in the system.

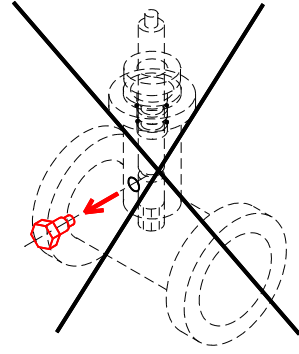

VETEC Ventiltechnik GmbH

Siemensstraße 12 · 67346 Speyer

Tel.: 0 62 32 64 12-0 · Fax: 0 62 32 4 24 79 · E-Mail: vetec@vetec.de · Internet: www.vetec.de

Freigabe und Genehmigung

Erstellt: Abt., Name P. Konzack Datum: 12.04.2005

Genehmigt: Abt., Name N. Hock Datum: 12.04.2005

Änderungen

Rev.	Datum	Revisor	Beschreibung
03	07.04.2006	fth	Typenschild-Zeichnung geändert
04	15.03.2021	fth	Layout geändert und Kap. / Betrieb mit Funktionsprüfung ergänzt